

SKF TMMK 10-35

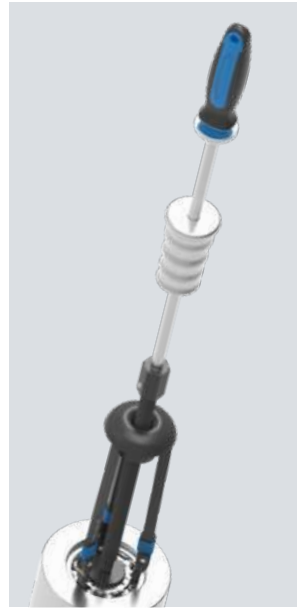

Instructions for use
Bedienungsanleitung
Instrucciones de uso
Mode d'emploi

Manuale d'istruzioni
Instruções de uso
Инструкция по эксплуатации
使用说明书

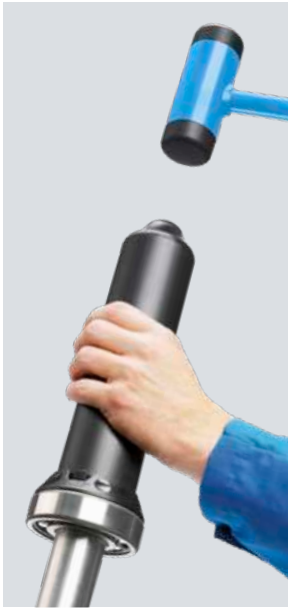
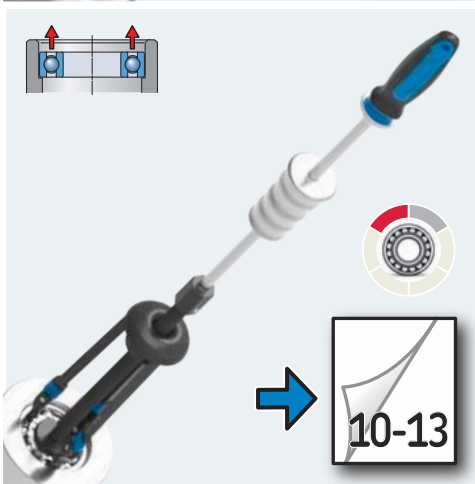
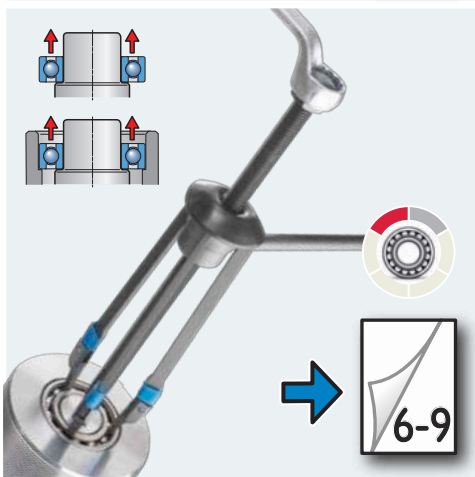
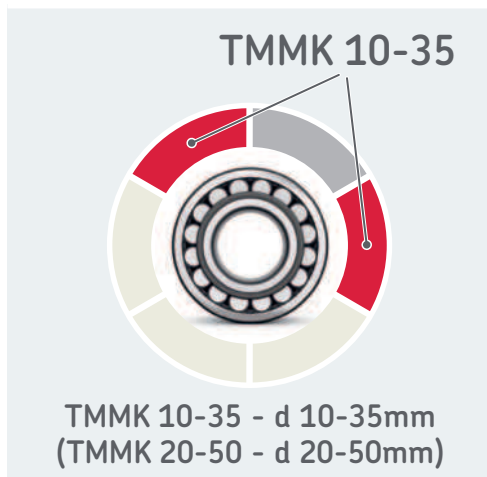
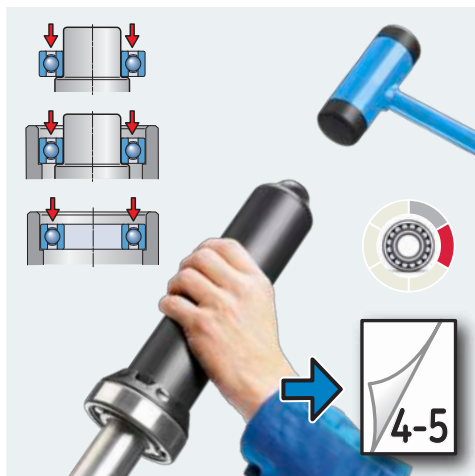
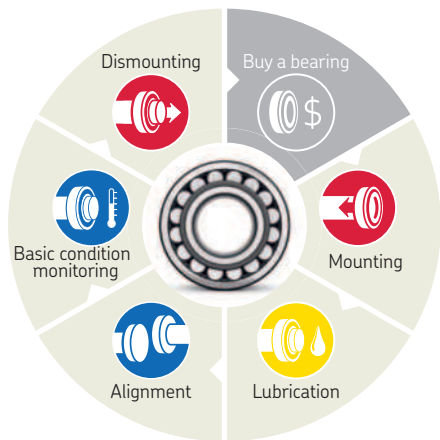

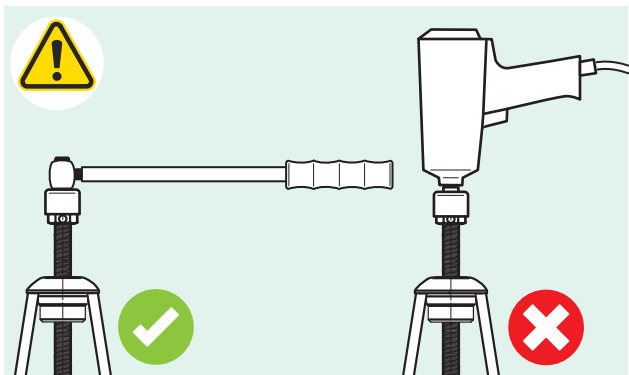
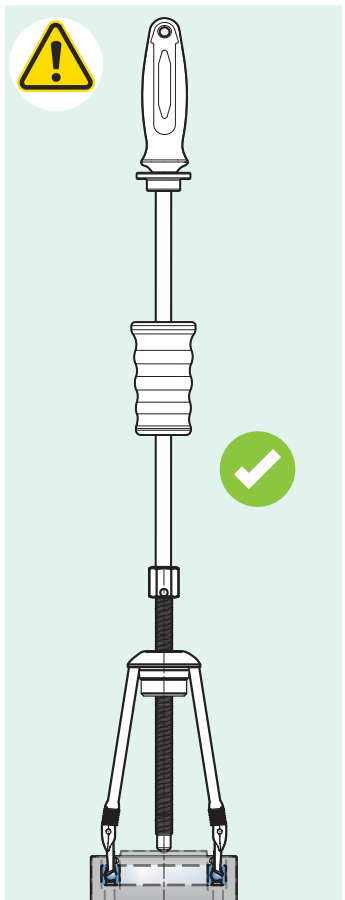
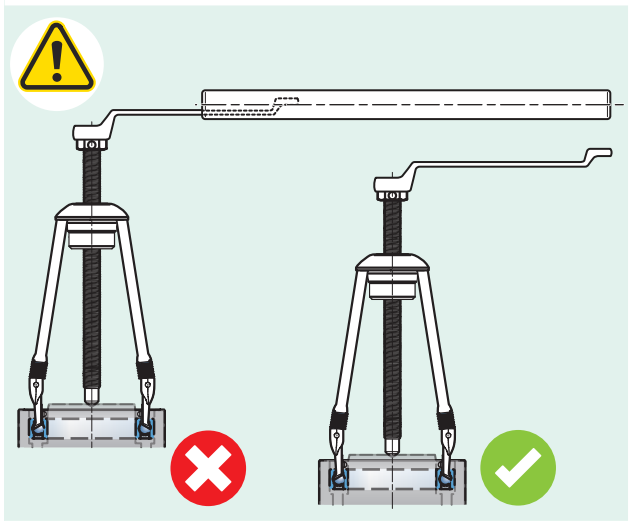
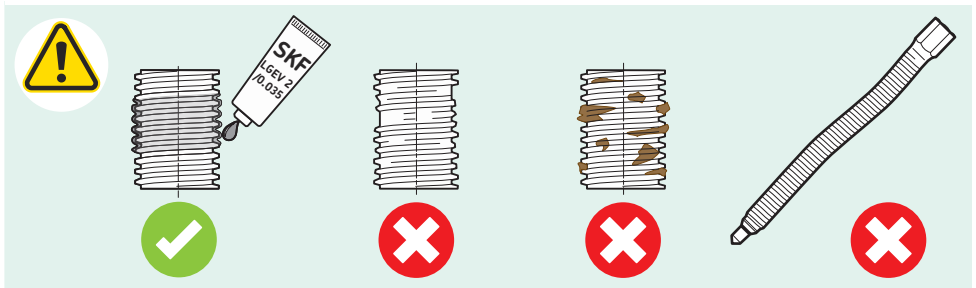
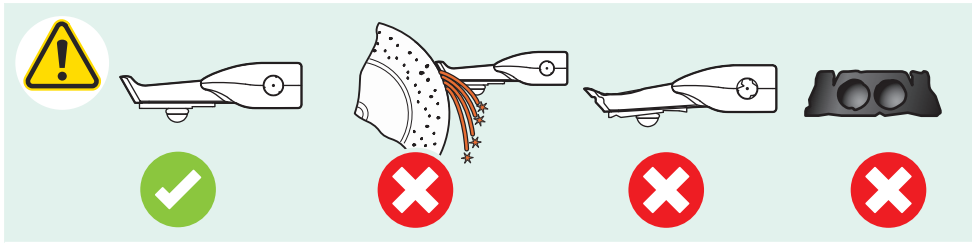

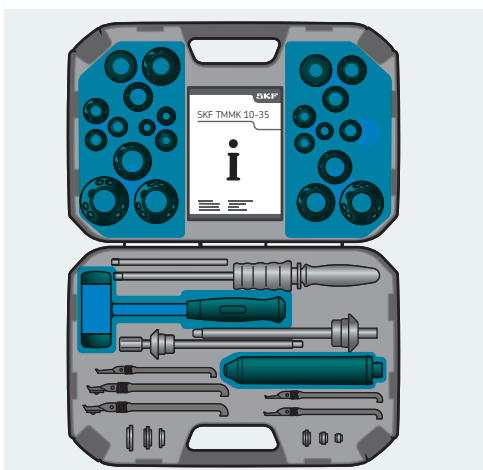
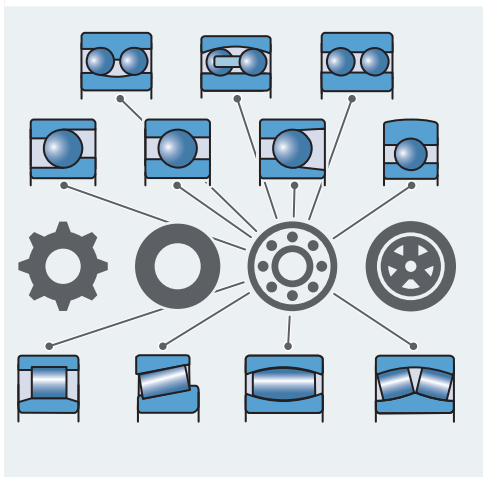
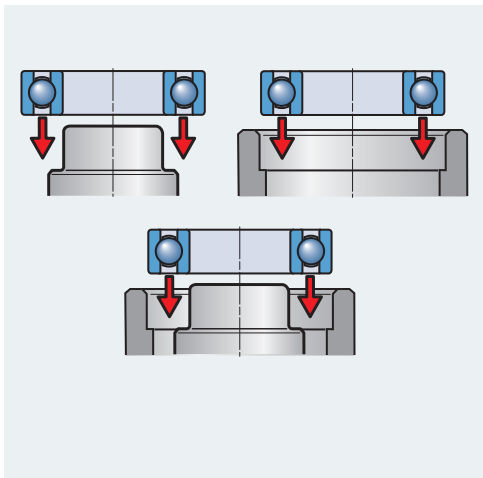

	d		D		60..	6
	mm	in	mm	in		
TMFT 36 A10-26	10	0.4	26	1.0	6000	6
TMFT 36 A10-30	10	0.4	30	1.2		6
TMFT 36 A10-35	10	0.4	35	1.4		6
TMFT 36 A12-28	12	0.5	28	1.1	6001	
TMFT 36 A12-32	12	0.5	32	1.3		6
TMFT 36 A12-37	12	0.5	37	1.5		6
TMFT 36 A15-32	15	0.6	32	1.3	6002	
TMFT 36 A15-35	15	0.6	35	1.4		6
TMFT 36 A15-42	15	0.6	42	1.7		6
TMFT 36 A17-35	17	0.7	35	1.4	6003	
TMFT 36 A17-40	17	0.7	40	1.6		6
TMFT 36 A17-47	17	0.7	47	1.9		6

	d		D		60..	6
	mm	in	mm	in		
TMFT 36 B20-42	20	0.8	42	1.6	6004	
TMFT 36 B20-47	20	0.8	47	1.8		6
TMFT 36 B20-52	20	0.8	52	2.0		6
TMFT 36 B25-47	25	1.0	47	1.9	6005	6
TMFT 36 B25-52	25	1.0	52	2.0		6
TMFT 36 B25-62	25	1.0	62	2.4		6
TMFT 36 B30-55	30	1.2	55	2.2	6006	6
TMFT 36 B30-62	30	1.2	62	2.4		6
TMFT 36 B30-72	30	1.2	72	2.8		6
TMFT 36 B35-62	35	1.4	62	2.4	6007	
TMFT 36 B35-72	35	1.4	72	2.8		6
TMFT 36 B35-80	35	1.4	80	3.1		6

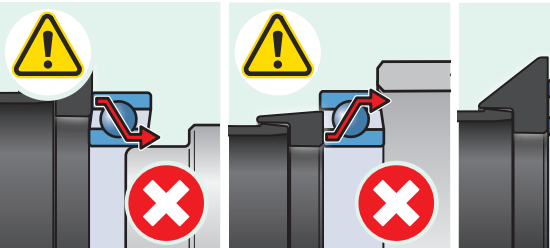

2..	63..	64..	161..
29			16100
200			6300
			16101
201			6301
202			6302
203			6303

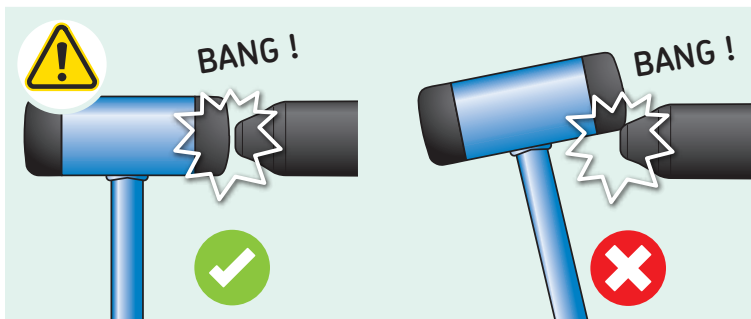

2..	63..	64..	160..
204			16004
			6304
2/22			16005
205	63/22		6305 6403
2/28			16006
206	63/28		6306 6404
			16007
207			6307 6405

1 ? ? ?

	d	D	GO.	62	63	64	160
TMFT 36 A10-26	10	0.4	26	1.0	6000		16100
TMFT 36 A10-30	10	0.4	30	1.2	6200		16101
TMFT 36 A10-35	10	0.4	35	1.4			
TMFT 36 A12-28	12	0.5	28	1.1	6001		16101
TMFT 36 A12-32	12	0.5	32	1.3	6201		
TMFT 36 A12-37	12	0.5	37	1.5			
TMFT 36 A15-30	15	0.6	32	1.3	6002		16005
TMFT 36 A15-35	15	0.6	35	1.4	6202		
TMFT 36 A15-42	15	0.6	42	1.7			
TMFT 36 A17-35	17	0.7	35	1.4	6003		16007
TMFT 36 A17-40	17	0.7	40	1.4	6203		
TMFT 36 A17-45	17	0.7	45	1.5			

? ? ?

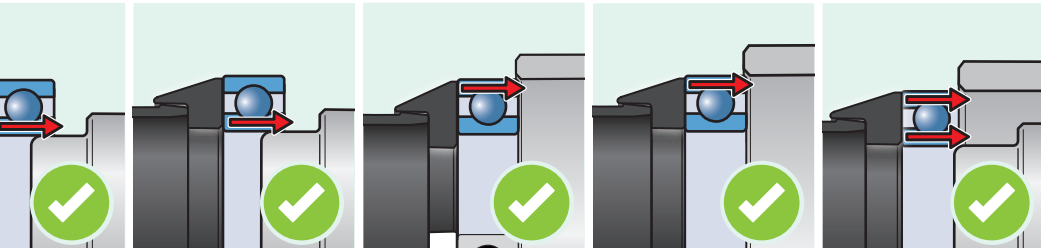
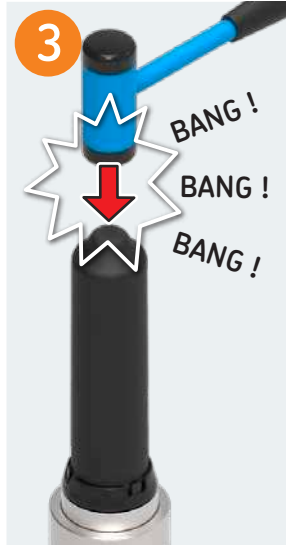

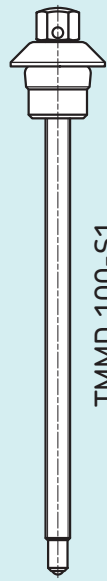
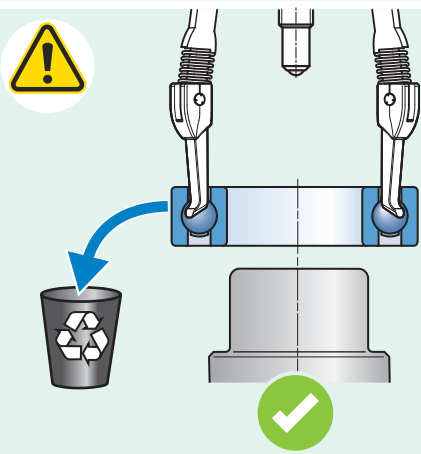
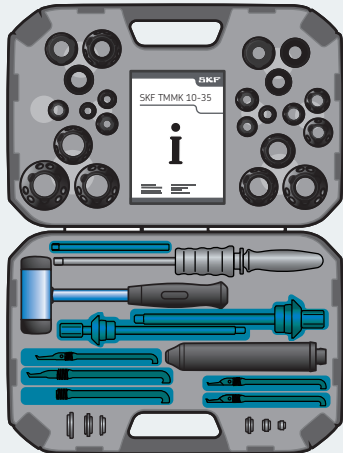
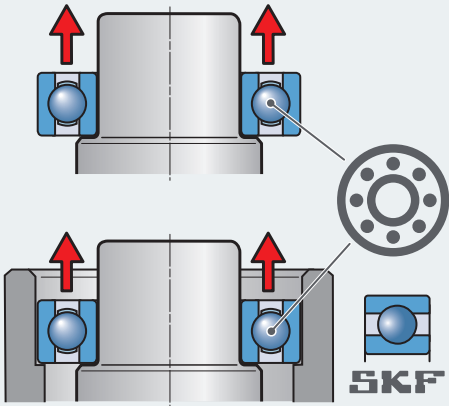

TMMD 100-A1



TMMD 100-S1

TMMD 100-A2



TMMD 100-A3

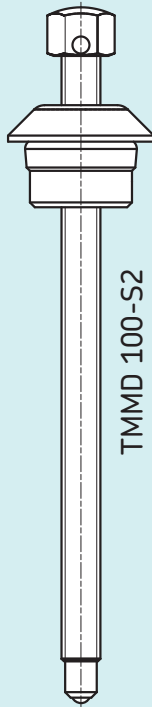























TMMD 100-A4



TMMD 100-S2

TMMD 100-A5



	60..	62..	63..	64..	160..
	6000	6200			16002
	6001				16003
	6002				16100
	6003				16101
	6004	6201			
	6005	6202			
	6006	6203			
	6007	6204	6300		16011
	6008	6205	6301		
	6009	62/22	6302		
	6010				
		6206	6303		
		62/28	6304		
	6011		63/22		
	6012				
	6013				
		6207	6305		
		6208	63/28		
	6014	6209	6306	6403	
	6015				
	6016	6210	6307		
	6017	6211			

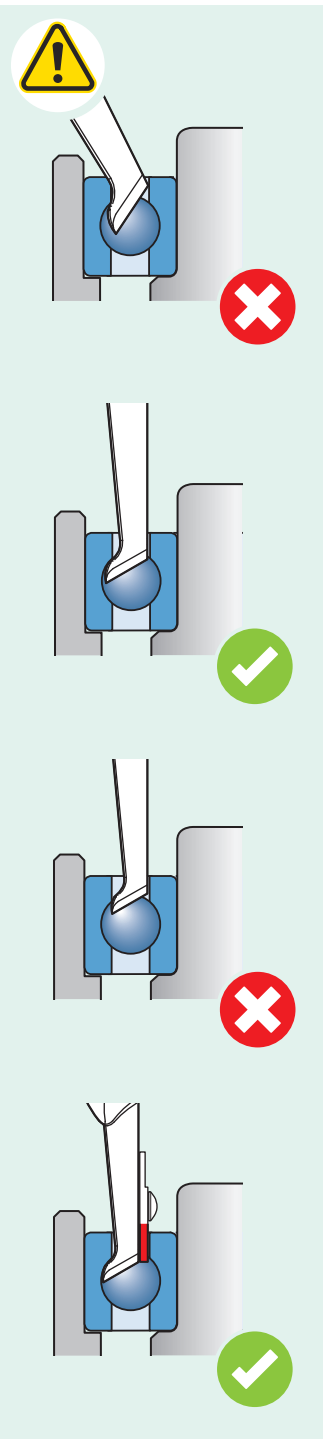

1 ? ? ?

	60.	62.	63.	64.	160.	161.
TMMD 100-A1	6001	6200	6300	6400	16000	16100
	6002				16001	16101
	6003					
TMMD 100-A2	6004	6201	6301	6401		
	6005	6202	6302	6402		
	6006	6203	6303	6403		
TMMD 100-A3	6007	6204	6300	6400		16011
	6008	6205	6301	6401		
	6009	6222	6302	6402		
	6010					
TMMD 100-A4		6206	6303	6403		
		6228	6304	6404		
	6011					
	6012					
	6013					
TMMD 100-A5		6207	6305	6405		
		6208	6306	6406		
		6209	6307	6407		
	6014	6210	6307	6407		
	6015	6211				
	6016		6308	6404		
	6017					
	6018					
	6019					
	6020					
TMMD 100-A6		6212				
		6213				
		6214	631			
		6215	631			
		6216	631			
		6217	631			
		6218	631			
		6219	631			
		6220	631			

6-7

2 A4/A5

x3

6-7

3 I

5 II

~120°

6 II

7 III

9

10

11

4

I

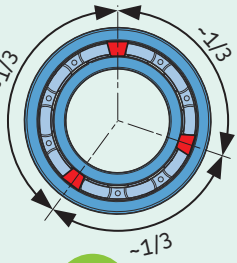
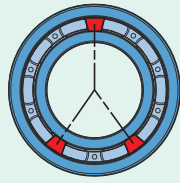
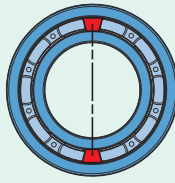
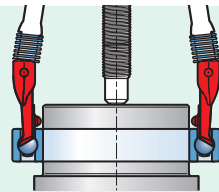

8

III

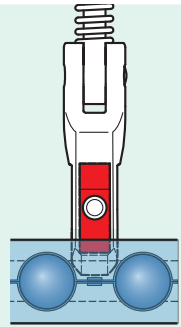
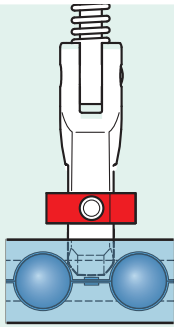
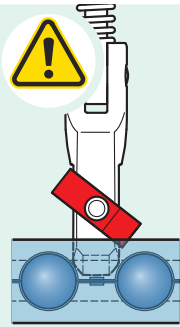

12

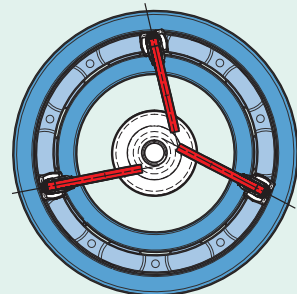
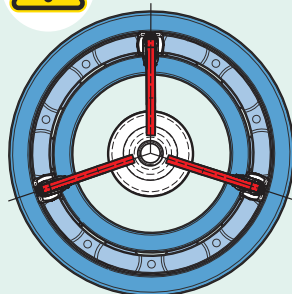

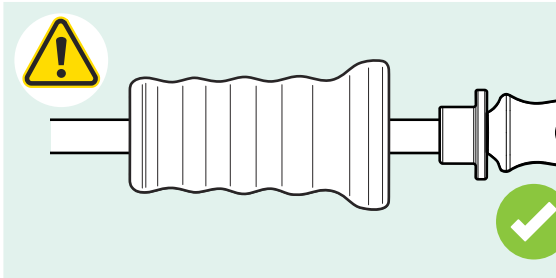
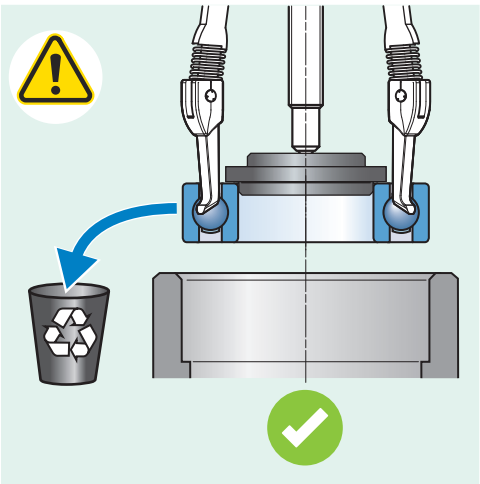
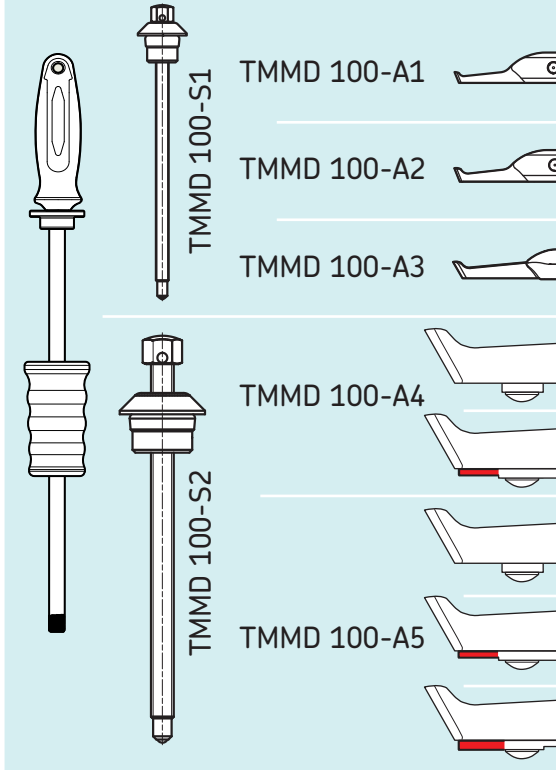
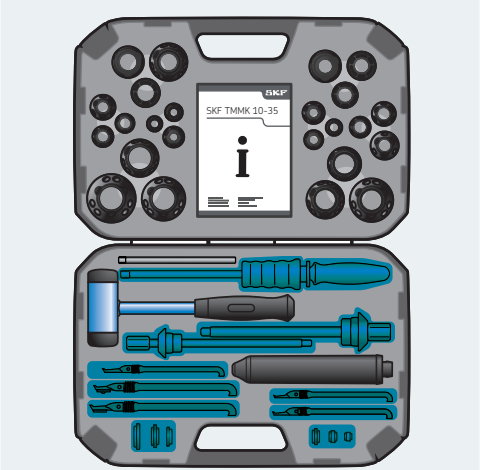
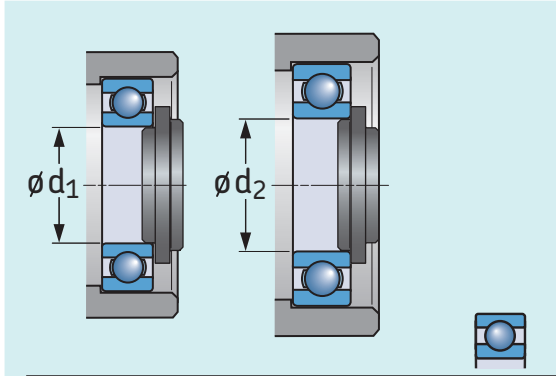
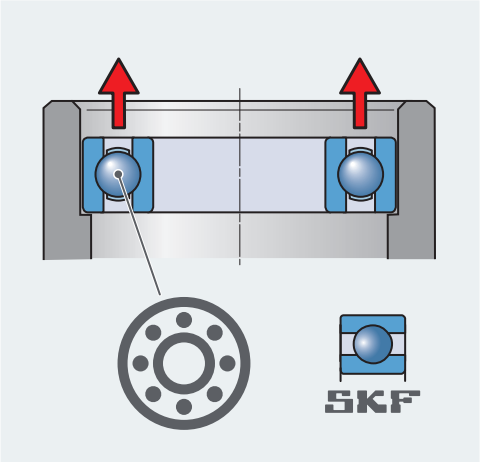



	d ₁	d ₂	d ₁	d ₂	d ₁	d ₂	d ₁	d ₁	d ₂	d ₁
mm	10	12	15	17	20	22	25	28	30	35
in	0.4	0.5	0.6	0.7	0.8	0.9	1.0	1.1	1.2	1.4
	6000 6200 16100	6001 16101	6002 16002	6003 16003						
		6201	6202	6203	6004		6005		6006	
	6300	6301	6302		6204	62/22	6205			6007
				6303	6304			62/28	6206	
						63/22				
							6305	63/28		6207
				6403					6306	
										6307

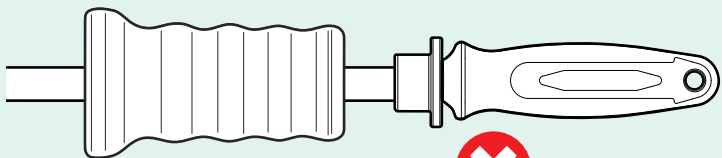
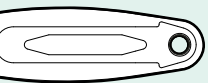

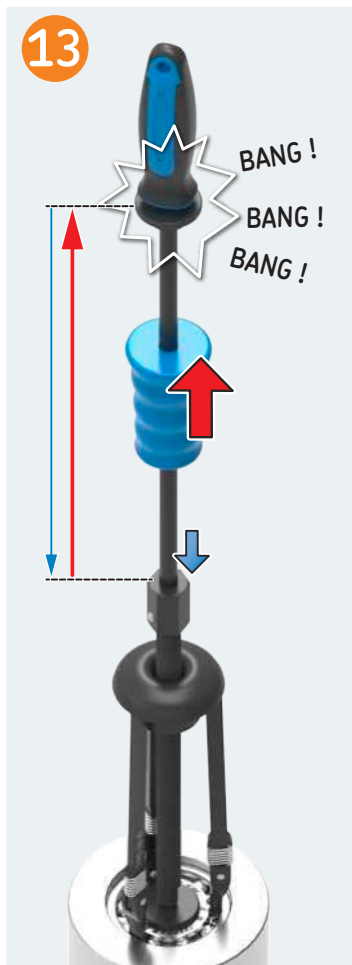
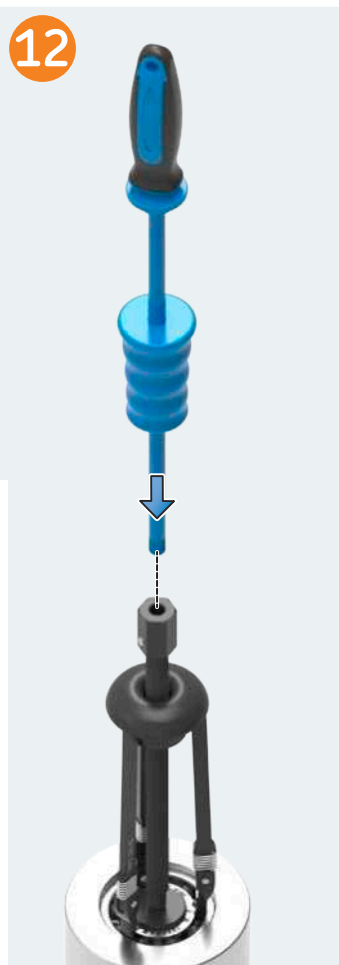
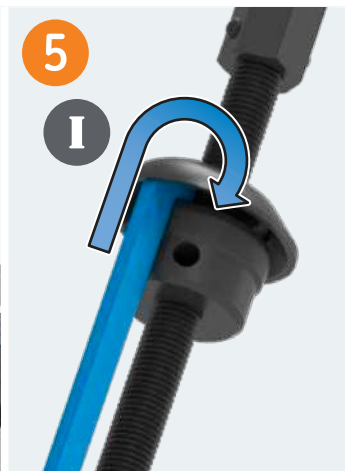

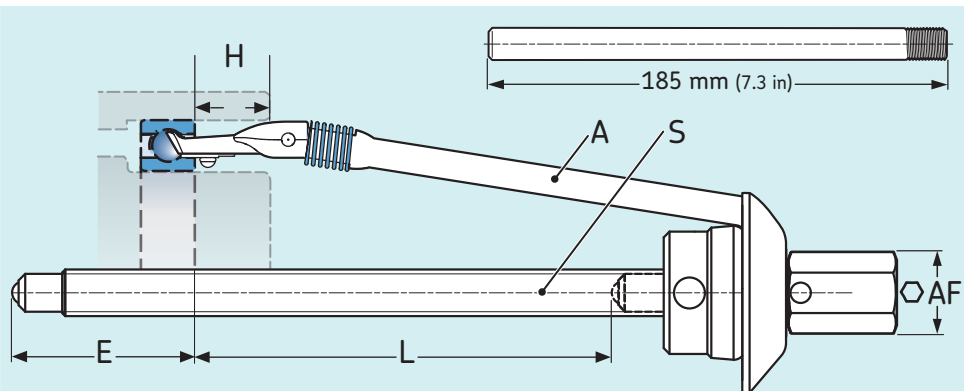

	S	A	L		H		E		AF	
			mm	in	mm	in	mm	in	mm	in
TMMD 100-S1		TMMD 100-A1	135	5.3	16	0.6	79	3.1		
		TMMD 100-A2	135	5.3	16	0.6	79	3.1	19	3/4
		TMMD 100-A3	137	5.4	23	0.9	77	3.0		
TMMD 100-S2		TMMD 100-A4	162	6.4	26	1.0	52	2.0	24	1
		TMMD 100-A5	167	6.6	52	2.0	49	1.9		

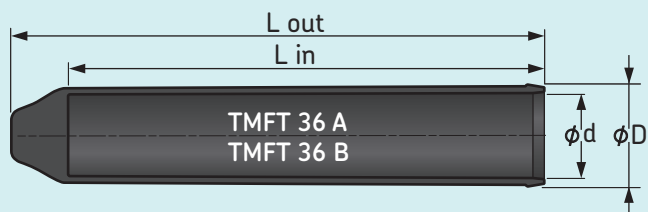

	d		D		L _{in}		L _{out}	
	mm	in	mm	in	mm	in	mm	in
TMFT 36 A	18	0.7	25	1.0	210	8.3	228	9.0
TMFT 36 B	37	1.4	45	1.7	210	8.3	235	9.3

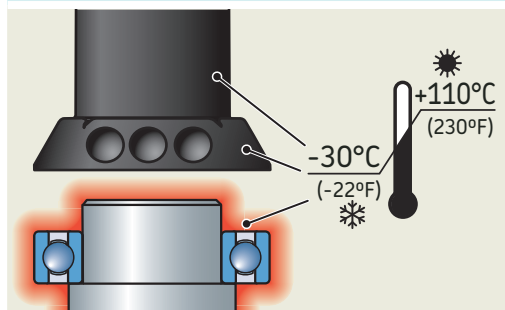
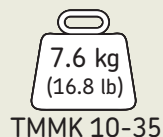

TMMK 10-35-CC

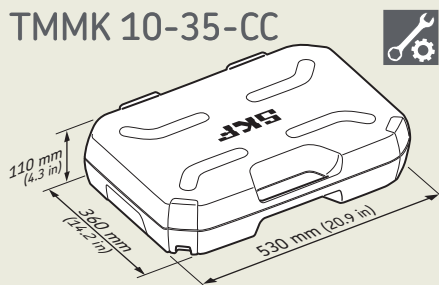

TMMX 210

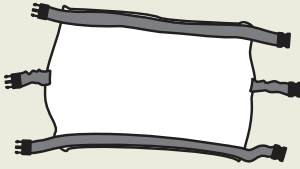

LGEV 2/0.035



TMFT 36 A..



TMFT 36 A10-26	TMFT 36 A12-28
TMFT 36 A10-30	TMFT 36 A12-32
TMFT 36 A10-35	TMFT 36 A12-37
TMFT 36 A15-32	TMFT 36 A17-35
TMFT 36 A15-35	TMFT 36 A17-40
TMFT 36 A15-42	TMFT 36 A17-47

TMMD 100-A1

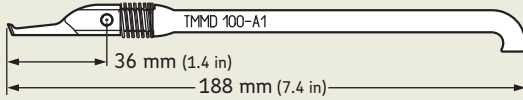

TMMD 100-A2

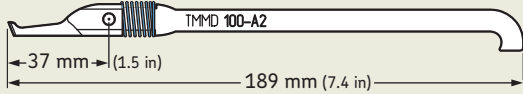

TMMD 100-A3

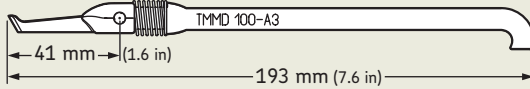

TMMD 100-A4

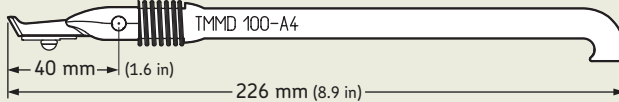

TMMD 100-A5

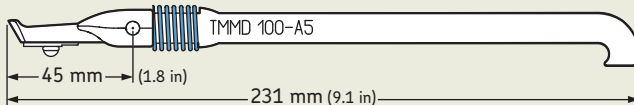

TMIP S1

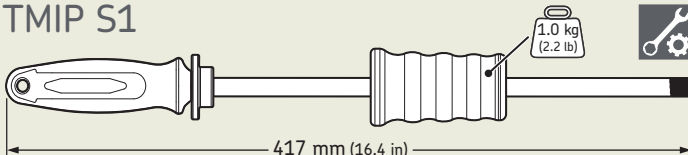

TMFT 36 B..

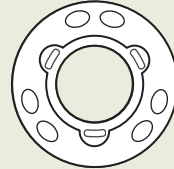

TMFT 36 B20-42	TMFT 36 B25-47
TMFT 36 B20-47	TMFT 36 B25-52
TMFT 36 B20-52	TMFT 36 B25-62
TMFT 36 B30-55	TMFT 36 B35-62
TMFT 36 B30-62	TMFT 36 B35-72
TMFT 36 B30-72	TMFT 36 B35-80

TMFT 36-H

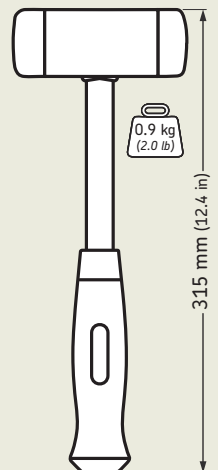

The contents of this publication are the copyright of the publisher and may not be reproduced (even extracts) unless prior written permission is granted. Every care has been taken to ensure the accuracy of the information contained in this publication but no liability can be accepted for any loss or damage whether direct, indirect or consequential arising out of the use of the information contained herein.

Nachdruck, auch auszugsweise, nur mit unserer vorherigen schriftlichen Genehmigung gestattet. Die Angaben in dieser Druckschrift wurden mit größter Sorgfalt auf ihre Richtigkeit hin überprüft. Trotzdem kann keine Haftung für Verluste oder Schäden irgendwelcher Art übernommen werden, die sich mittelbar oder unmittelbar aus der Verwendung der hier enthaltenen Informationen ergeben.

El contenido de esta publicación es propiedad de los editores y no puede reproducirse (incluso parcialmente) sin autorización previa por escrito. Se ha tenido el máximo cuidado para garantizar la exactitud de la información contenida en esta publicación, pero no se acepta ninguna responsabilidad por pérdidas o daños, ya sean directos, indirectos o consecuentes, que se produzcan como resultado del uso de dicha información.

Le contenu de cette publication est soumis au copyright de l'éditeur et sa reproduction, même partielle, est interdite sans autorisation écrite préalable. Le plus grand soin a été apporté à l'exactitude des informations données dans cette publication mais SKF décline toute responsabilité pour les pertes ou dommages directs ou indirects découlant de l'utilisation du contenu du présent document.

La riproduzione, anche parziale, del contenuto di questa pubblicazione è consentita soltanto previa autorizzazione scritta della SKF. Nella stesura è stata dedicata la massima attenzione al fine di assicurare l'accuratezza dei dati, tuttavia non si possono accettare responsabilità per eventuali errori od omissioni, nonché per danni o perdite diretti o indiretti derivanti dall'uso delle informazioni qui contenute.

O conteúdo desta publicação é de direito autoral do editor e não pode ser reproduzido (nem mesmo parcialmente), a não ser com permissão prévia por escrito. Todo cuidado foi tomado para assegurar a precisão das informações contidas nesta publicação, mas nenhuma responsabilidade pode ser aceita por qualquer perda ou dano, seja direto, indireto ou consequente como resultado do uso das informações aqui contidas.

Содержание этой публикации является собственностью издателя и не может быть воспроизведено (даже частично) без предварительного письменного разрешения. Несмотря на то, что были приняты все меры по обеспечению точности информации, содержащейся в настоящем издании, издатель не несет ответственности за любой ущерб, прямой или косвенный, вытекающий из использования вышеуказанной информации.

本出版物内容的著作权归出版者所有且未经事先书面许可不得被复制（甚至引用）。我们已采取了一切注意措施以确保本出版物包含的信息准确无误，但我们不对因使用此等信息而产生的任何损失或损害承担任何责任，不论此等责任是直接、间接或附随性的。

RU РУССКИЙ ДОПОЛНИТЕЛЬНАЯ ИНФОРМАЦИЯ

Информация об уполномоченном лице и контактной информации для связи с ним:

ООО «СКФ»

121552, город Москва, улица Ярцевская, д.19, Блок А, Этаж 7.

Телефон: +7 495 215-1006

E-mail: SKF.Moscow@skf.com



skf.com | mapro.skf.com | skf.com/mount

© SKF is a registered trademark of the SKF Group.

© SKF Group 2021

MP5344 · 2021/10