

SKF SYSTEM 24

TLSD Series



Instructions for use
Bedienungsanleitung
Instrucciones de uso
Mode d'emploi

Manuale d'istruzioni
Instruções de uso
Инструкция по эксплуатации
使用说明书

EU Declaration of Conformity SKF SYSTEM 24 TLSD Series

We, SKF MPT, Meidoornkade 14, 3992 AE Houten, The Netherlands herewith declare under our sole responsibility that the products described in these instructions for use, are in accordance with the conditions of the following Directive(s):

EMC DIRECTIVE 2014/30/EU

RoHS DIRECTIVE (EU) 2015/863

and are in conformity with the following standards:

EN61000-6-2:2005,

EN 61000-6-3:2007/A1:2011/AC:2012

Electromagnetic compatibility (EMC).

Generic standards. Emission standard

for residential, commercial and light-industrial environments,

EN61000-4-2, EN61000-4-3,

EN61000-4-8

Houten, The Netherlands, February 2023

Guillaume Dubois

Manager Quality and Compliance



UK Declaration of Conformity SKF SYSTEM 24 TLSD Series

We, SKF MPT, Meidoornkade 14, 3992 AE Houten, The Netherlands herewith declare under our sole responsibility that the products described in these instructions for use, are in accordance with the conditions of the following Directive(s):

Electromagnetic Compatibility

Regulations 2016 (2016 No. 1091)

The Restriction of the Use of Certain Hazardous Substances in Electrical and Electronic Equipment Regulations 2012 (2012 No. 3032) and are in conformity with the following standards:

EN61000-6-2:2005,

EN 61000-6-3:2007/A1:2011/AC:2012

Electromagnetic compatibility (EMC).

Generic standards. Emission standard for residential, commercial and light-industrial environments,

EN61000-4-2, EN61000-4-3,

EN61000-4-8

The person authorised to compile the technical documentation on behalf of the manufacturer is SKF (U.K.) Limited, 2 Canada Close, Banbury, Oxfordshire, OX16 2RT, GBR.

Houten, The Netherlands, February 2023

Guillaume Dubois

Manager Quality and Compliance



TMBA G11DB



MP5409





www.skf.com/lubrication



LGFP 2
LHMT 68
LHFP 150
LHHT 265



Safety recommendations

English

- At prolonged low temperatures there is a small risk that the battery pack capacity will not allow the full lubricant content to be dispensed.
- Under such operating conditions, it is recommended to exchange the battery pack when half the lubricant is dispensed.
- **Warning:** If the battery pack is exchanged then the empty canister indicator could be disabled.

Français

- Pendant une exposition prolongée à basses températures, il se peut que la capacité des batteries ne permette pas la distribution totale du lubrifiant.
- Dans de telles conditions, il est recommandé de changer les batteries quand la moitié du lubrifiant a été distribuée.
- **Attention:** si les batteries sont remplacées, l'indicateur de réservoir vide pourrait ne plus fonctionner.

Deutsch

- Bei anhaltenden geringen Temperaturen ist in seltenen Fällen möglich, dass die Batterien vor vollständiger Entleerung der Kartusche entladen sind.
- Ist der Füllstand um 50% gesunken, ist es unter solchen Bedingungen ratsam, die Batterien vorzeitig auszutauschen.
- **Hinweis:** Nach Austausch der Batterien könnte die Warnanzeige für die vollständige Entleerung des Schmierstoffbehälters deaktiviert werden.

Español

- A temperaturas bajas prolongadas existe un pequeño riesgo que la capacidad del paquete de la batería no permitirá que el contenido completo del lubricante sea dispensado.
- Bajo tales condiciones de funcionamiento, se recomienda intercambiar el paquete de la batería cuando la mitad del lubricante sea dispensado.
- **Advertencia:** Si el paquete de la batería se intercambia entonces el indicador del frasco vacío podría estar desactivado.

Italiano

- Con l'esposizione prolungata alle basse temperature sussiste un minimo rischio che la capacità del pacco batteria impedisca la completa erogazione del lubrificante.
- Qualora sussistano tali condizioni di funzionamento, si consiglia di sostituire il pacco batteria non appena il lubrificante sia stato erogato per metà.
- **Attenzione:** quando si sostituisce il pacco batteria, l'indicatore di livello del contenitore potrebbe essere disabilitato.

Svenska

- Vid långvarig låg temperatur finns en liten risk att batteripaketets kapacitet inte räcker till att tömma hela smörjmängden i behållaren.
- Vid sådana driftsförhållanden rekommenderas att byta batteripaketet efter att halva behållaren tömts.
- **Varning:** Om batteripaketet byts, kan indikator för tom behållare komma att inaktiveras.

Nederlands

- Bij langdurige perioden met lage temperaturen is er een kleine kans dat de capaciteit van de batterij onvoldoende is om de volledige inhoud van de smeereinheid te leveren.
- Het is raadzaam om onder deze omstandigheden de batterij halverwege de doseertijd te vervangen.
- **Pas op:** Bij het vervangen van de batterij kan de LED indicatie van een lege smeereinheid uitgezet worden.

Português

- Diante de temperaturas baixas por um tempo prolongado, existe um pequeno risco de que a capacidade do conjunto de baterias não permita que seja suprido o conteúdo total do lubrificante.
- Em face de tais condições operacionais, recomenda-se a substituição do conjunto de baterias quando a metade do lubrificante tiver sido distribuída.
- **Atenção:** Se o conjunto de baterias for substituído então o indicador de que o tambor está vazio pode ser desativado.

中文

- 在长期的低温状态下,存在着电池容量受温度影响不足以分配所有的润滑剂的可能。
- 在这种工况下,建议当润滑剂分配一半后更换电池组。
- **警告:** 电池组被更换后,该单点润滑器的空罐指示灯将失效。

Русский

- При продолжительной работе при низких температурах существует небольшой риск, что ёмкость батареи не обеспечит достаточной мощности для подачи всего объёма смазочного вещества.
- При таких условиях работы рекомендуется менять батарею после того, как была израсходована половина объёма смазочного вещества.
- Предупреждение: после замены батареи можно отключить индикатор пустой ёмкости.

RU РУССКИЙ ДОПОЛНИТЕЛЬНАЯ ИНФОРМАЦИЯ

Уполномоченное изготовителем лицо:

ООО «СКФ»

121552, город Москва, улица Ярцевская, д.19, Блок А, Этаж 7.

Телефон: +7 495 215-1006

E-mail: SKF.Moscow@skf.com



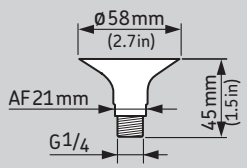
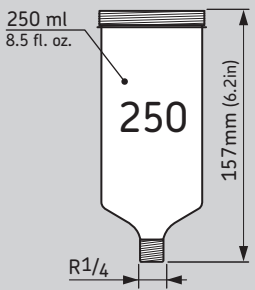
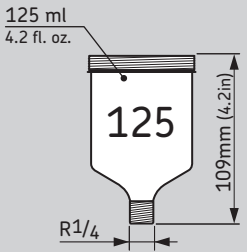
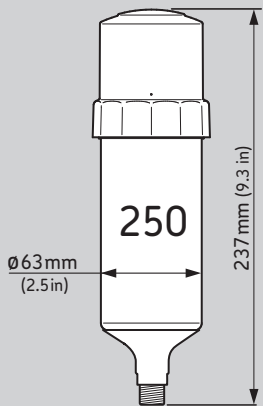
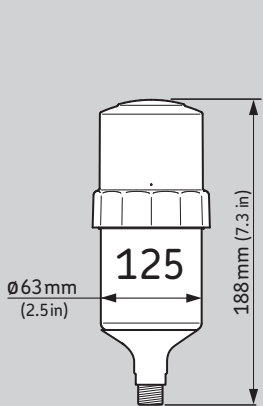
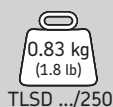
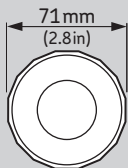
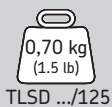



Max.
5 bar
(72 psi)



Max.
3 bar
(43 psi)

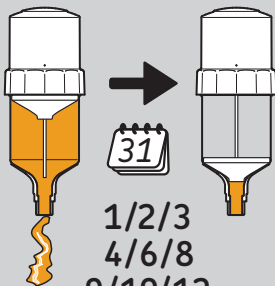

1/2/3
4/6/8
9/10/12
months



IP65



TLSD 1-BAT



EU Code:
160604







TLSD 1-BATC





EU Code:
160605

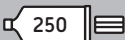

EU Code:
150110

|  LG.. |  |  |  |  |
|--|---|---|---|---|
| LGWA 2 | TLSD 125/WA2 | TLSD 250/WA2 | LGWA 2/SD125 | LGWA 2/SD250 |
| LGEM 2 | TLSD 125/EM2 | TLSD 250/EM2 | LGEM 2/SD125 | LGEM 2/SD250 |
| LGHB 2 | TLSD 125/HB2 | TLSD 250/HB2 | LGHB 2/SD125 | LGHB 2/SD250 |
| LGHP 2 | TLSD 125/HP2 | TLSD 250/HP2 | LGHP 2/SD125 | LGHP 2/SD250 |
| LGFP 2 | TLSD 125/FP2 | TLSD 250/FP2 | LGFP 2/SD125 | LGFP 2/SD250 |
|  LH.. | | | | |
| LHMT68 | TLSD 125/HMT68 | TLSD 250/HMT68 | LHMT 68/SD125 | LHMT 68/SD250 |
| LHHT 265 | | | | LHHT 265/SD250 |
| LHFP 150 | | | LHFP 150/SD125 | LHFP 150/SD250 |

|  31 months |  |  |
|--|---|---|
| OFF | 0 ml/day | 0 ml/day |
| 1M | 4,1 ml/day | 8,2 ml/day |
| 2M | 2,0 ml/day | 4,1 ml/day |
| 3M | 1,4 ml/day | 2,7 ml/day |
| 4M | 1,0 ml/day | 2,0 ml/day |
| 6M | 0,7 ml/day | 1,4 ml/day |
| 8M | 0,5 ml/day | 1,0 ml/day |
| 9M | 0,5 ml/day | 0,9 ml/day |
| 10M | 0,4 ml/day | 0,8 ml/day |
| 12M | 0,3 ml/day | 0,7 ml/day |

30 s

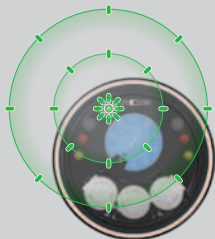

OK

2 s

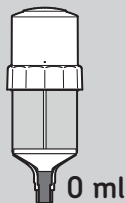
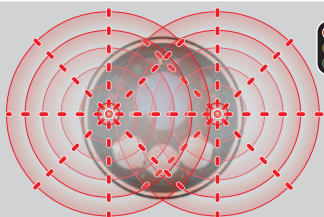

STOP

5 s

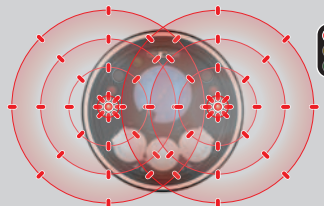

↓
> 5 bar
(72 psi)



ERROR
STOP

5 s

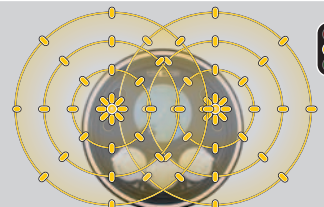

↓
~ 5 bar
(72 psi)



30 s

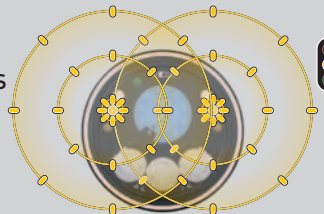

TLSD 1-BAT
0°C - 50°C
(32°F - 122°F)

TLSD 1-BATC
-10°C - 50°C
(14°F - 122°F)

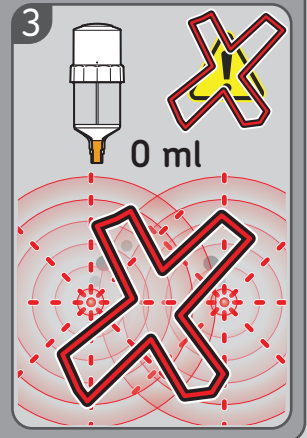
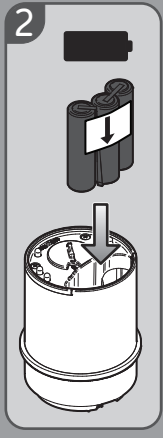
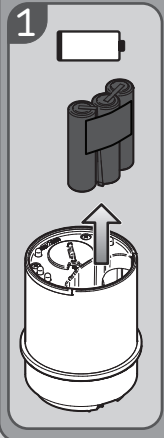
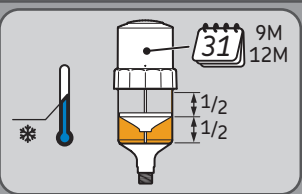
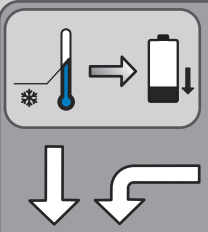
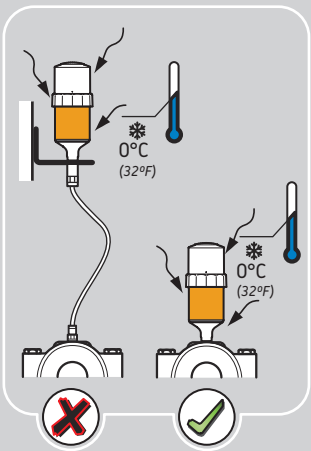

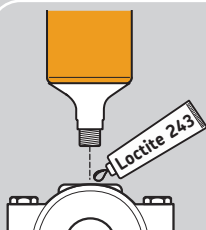
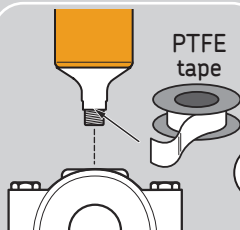
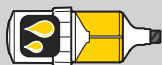

LAPT

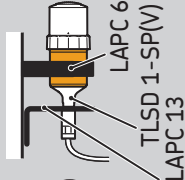
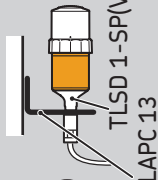
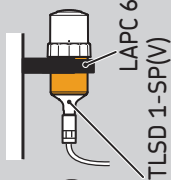

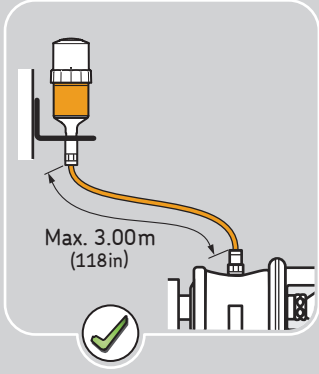
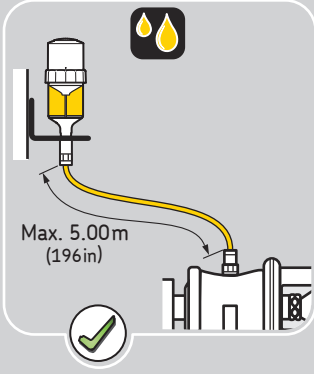
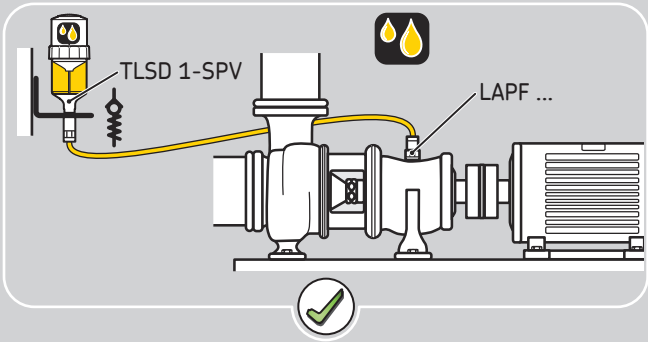
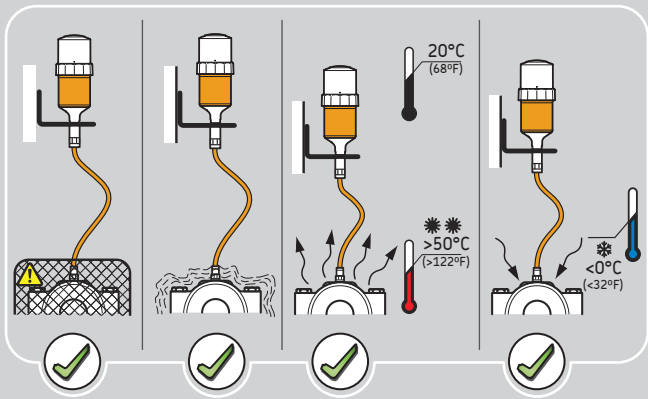

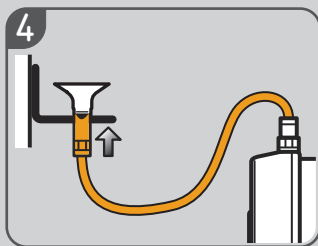
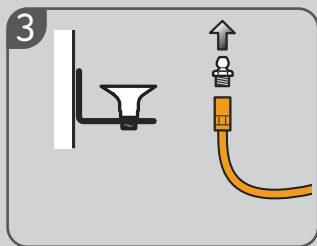
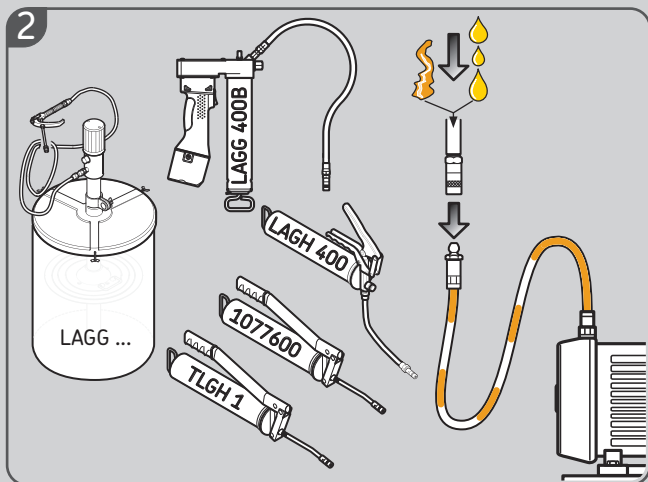
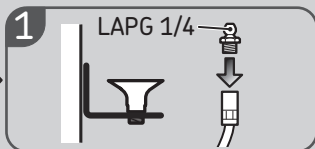
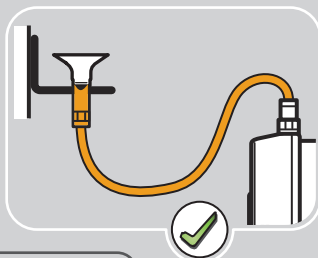
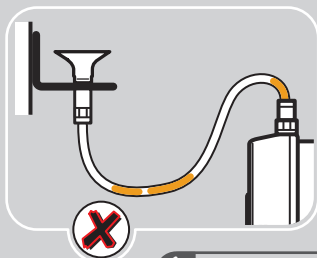

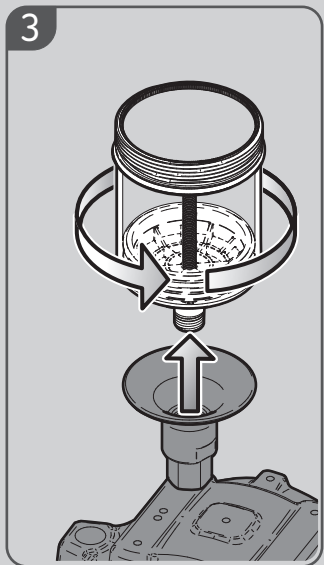
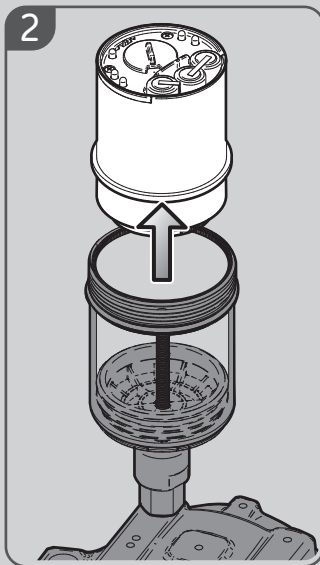
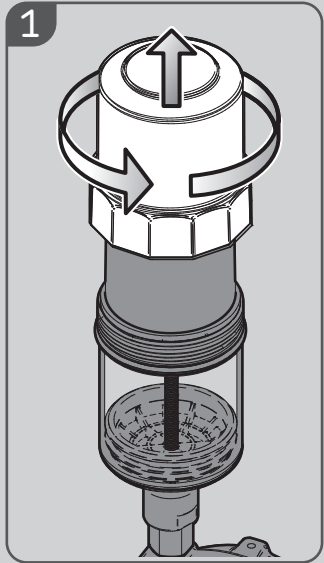
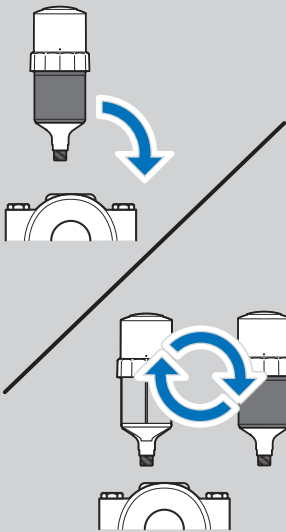

4

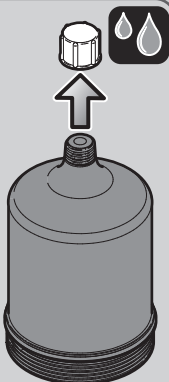
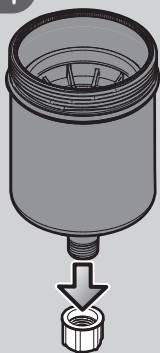

5

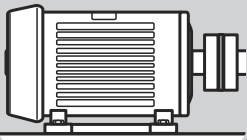
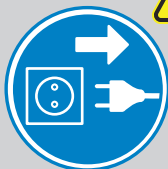

6



7

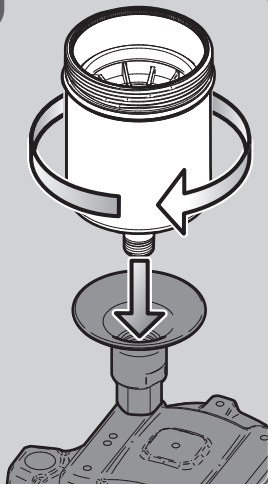

8

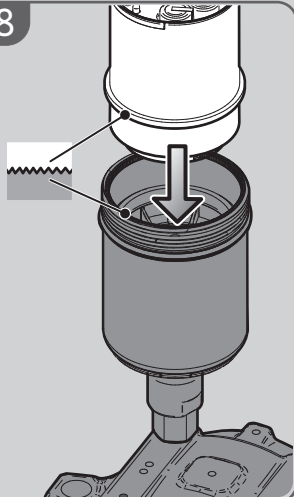

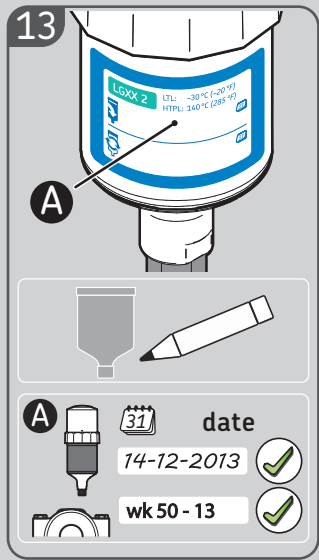
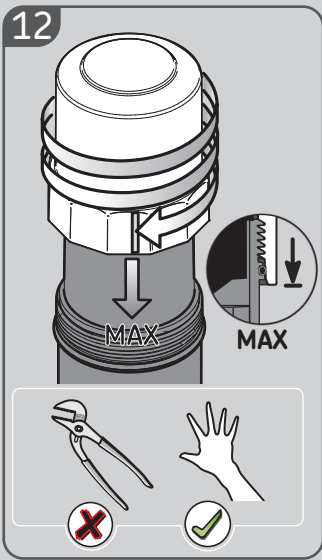
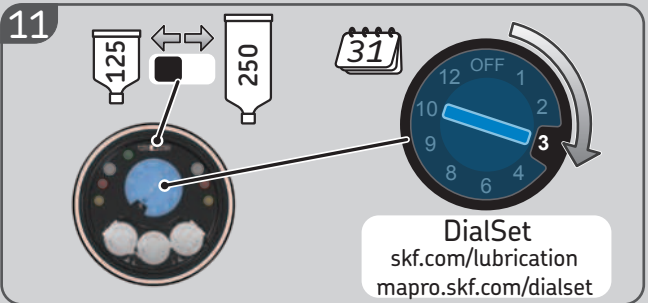
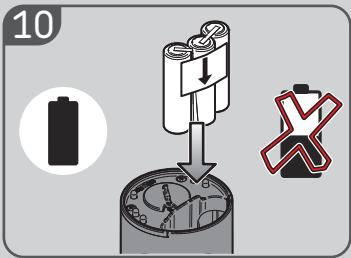
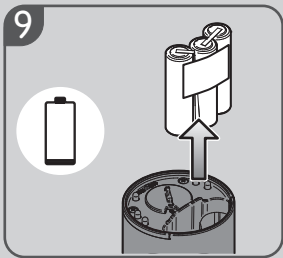

14

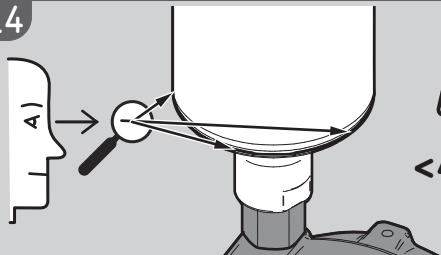

<4 days

15

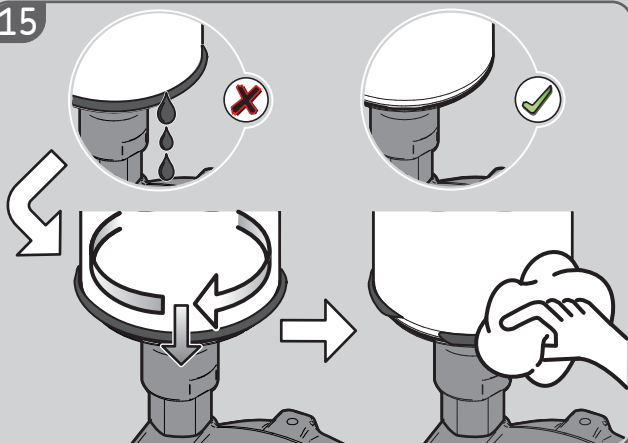

16

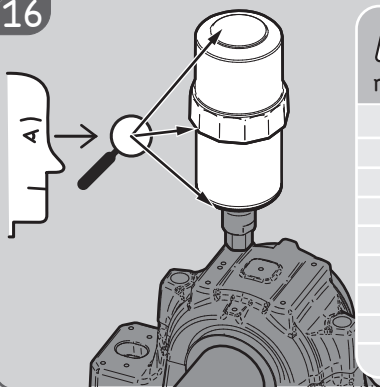

31

months



days

| | | |
|-----|--------|------|
| 1M | > 4 x | < 7 |
| 2M | > 4 x | < 14 |
| 3M | > 4 x | < 22 |
| 4M | > 4 x | < 30 |
| 6M | > 6 x | < 30 |
| 8M | > 8 x | < 30 |
| 9M | > 9 x | < 30 |
| 10M | > 10 x | < 30 |
| 12M | > 12 x | < 30 |

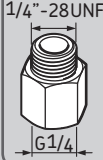
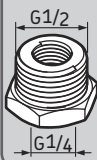
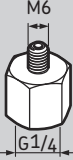
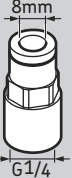
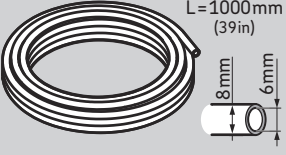
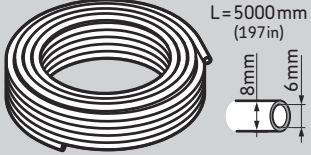
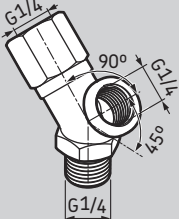
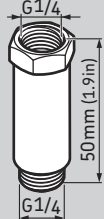
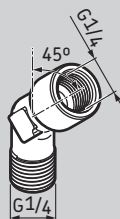
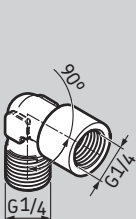
LAPN 1/8**LAPN 1/4****LAPN 1/4UNF****LAPN 3/8****LAPN 1/2****LAPN 6****LAPN 8****LAPN 8x1****LAPN 10****LAPN 10x1****LAPN 12****LAPN 12x1.5****LAPF F1/4****LAPF M1/8****LAPF M1/4****LAPF M3/8****LAPE 35****LAPT 1000****LAPT 5000****LAPM 2****LAPE 50****LAPA 45****LAPA 90**

TLSD 1-BAT



TLSD 1-BATC



LAPG 1/4



TLSD 1-SP

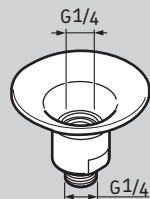

LAPC 13

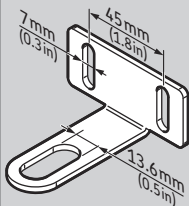

LAPC 63

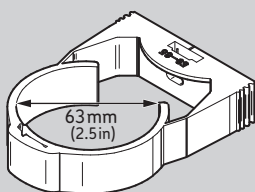

TLSD 1-SPV



LAPV 1/4



LAPV 1/8

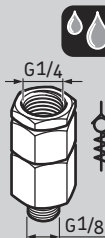

LAPB 5-16E1

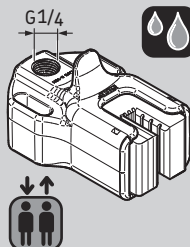

LAPB 3x4E1

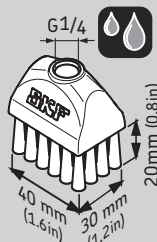

LAPB 3x7E1

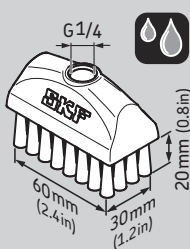

LAPB 3x10E1

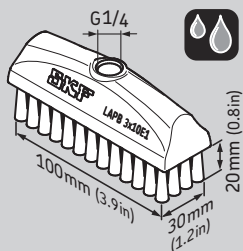

The contents of this publication are the copyright of the publisher and may not be reproduced (even extracts) unless prior written permission is granted. Every care has been taken to ensure the accuracy of the information contained in this publication but no liability can be accepted for any loss or damage whether direct, indirect or consequential arising out of the use of the information contained herein.

Nachdruck, auch auszugsweise, nur mit unserer vorherigen schriftlichen Genehmigung gestattet. Die Angaben in dieser Druckschrift wurden mit größter Sorgfalt auf ihre Richtigkeit hin überprüft. Trotzdem kann keine Haftung für Verluste oder Schäden irgendwelcher Art übernommen werden, die sich mittelbar oder unmittelbar aus der Verwendung der hier enthaltenen Informationen ergeben.

El contenido de esta publicación es propiedad de los editores y no puede reproducirse (incluso parcialmente) sin autorización previa por escrito. Se ha tenido el máximo cuidado para garantizar la exactitud de la información contenida en esta publicación, pero no se acepta ninguna responsabilidad por pérdidas o daños, ya sean directos, indirectos o consecuentes, que se produzcan como resultado del uso de dicha información.

Le contenu de cette publication est soumis au copyright de l'éditeur et sa reproduction, même partielle, est interdite sans autorisation écrite préalable. Le plus grand soin a été apporté à l'exactitude des informations données dans cette publication mais SKF décline toute responsabilité pour les pertes ou dommages directs ou indirects découlant de l'utilisation du contenu du présent document.

La riproduzione, anche parziale, del contenuto di questa pubblicazione è consentita soltanto previa autorizzazione scritta della SKF. Nella stesura è stata dedicata la massima attenzione al fine di assicurare l'accuratezza dei dati, tuttavia non si possono accettare responsabilità per eventuali errori od omissioni, nonché per danni o perdite diretti o indiretti derivanti dall'uso delle informazioni qui contenute.

O conteúdo desta publicação é de direito autoral do editor e não pode ser reproduzido (nem mesmo parcialmente), a não ser com permissão prévia por escrito. Todo cuidado foi tomado para assegurar a precisão das informações contidas nesta publicação, mas nenhuma responsabilidade pode ser aceita por qualquer perda ou dano, seja direto, indireto ou consequente como resultado do uso das informações aqui contidas.

Содержание этой публикации является собственностью издателя и не может быть воспроизведено (даже частично) без предварительного письменного разрешения. Несмотря на то, что были приняты все меры по обеспечению точности информации, содержащейся в настоящем издании, издатель не несет ответственности за любой ущерб, прямой или косвенный, вытекающий из использования вышеуказанной информации.

本出版物内容的著作权归出版者所有且未经事先书面许可不得被复制(甚至引用)。我们已采取了一切注意措施以确定本出版物包含的信息准确无误,但我们不对因使用此等信息而产生的任何损失或损害承担任何责任,不论此等责任是直接、间接或附属性的。



skf.com • skf.com/mapro

® SKF is a registered trademark of the SKF Group.

© SKF Group 2023

MP5409 • 2023/02