

SKF TMMK 20-50

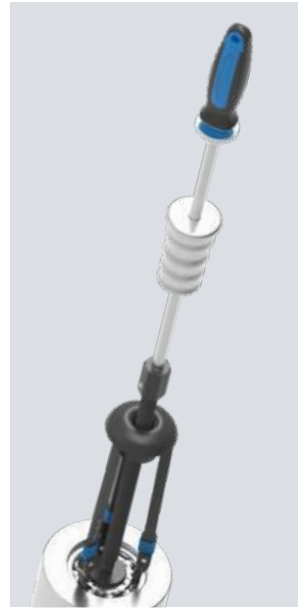

Instructions for use
Bedienungsanleitung
Instrucciones de uso
Mode d'emploi

Manuale d'istruzioni
Instruções de uso
Инструкция по эксплуатации
使用说明书

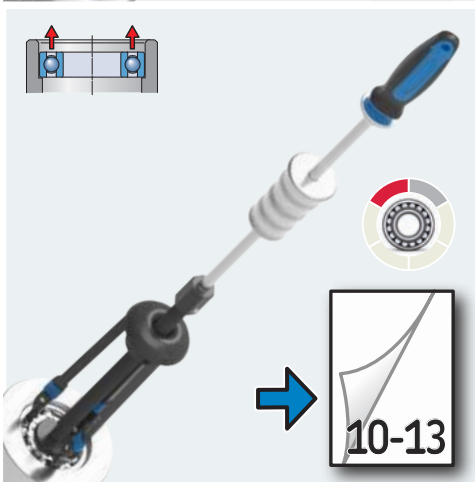
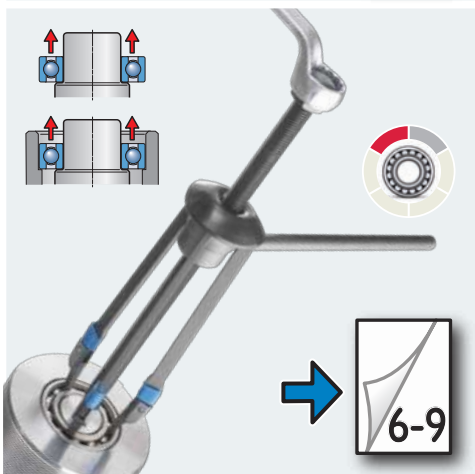
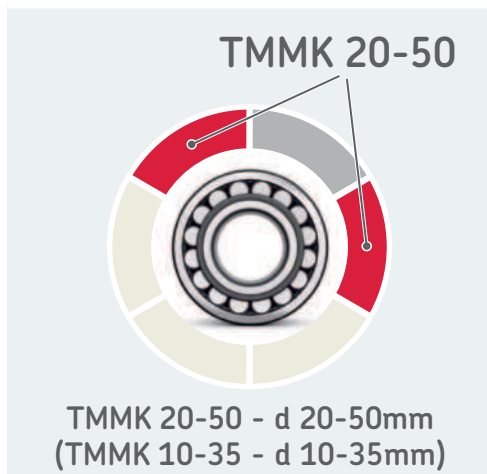
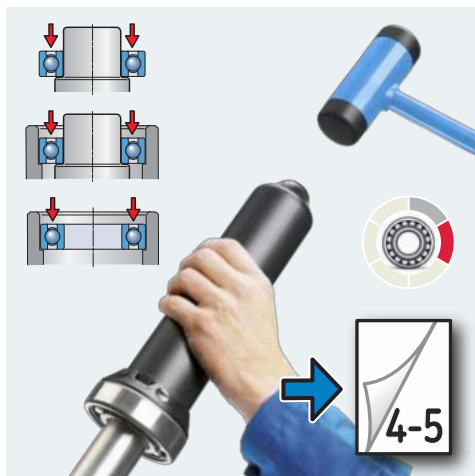
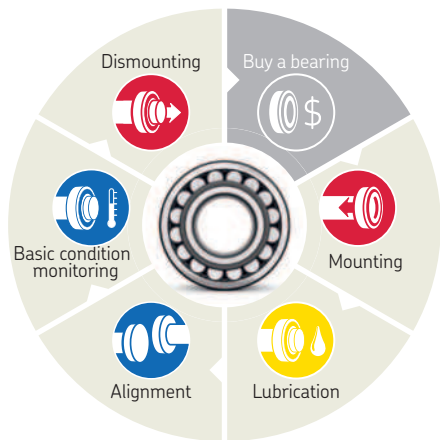

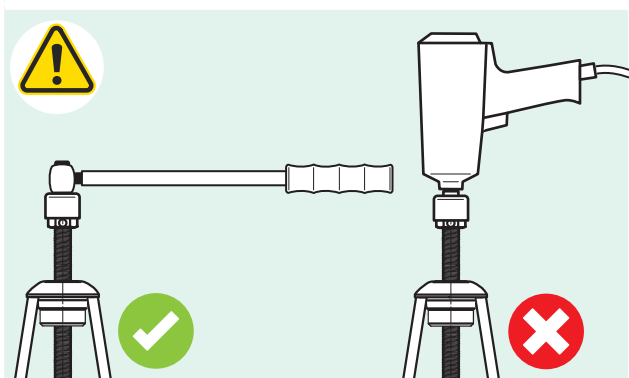
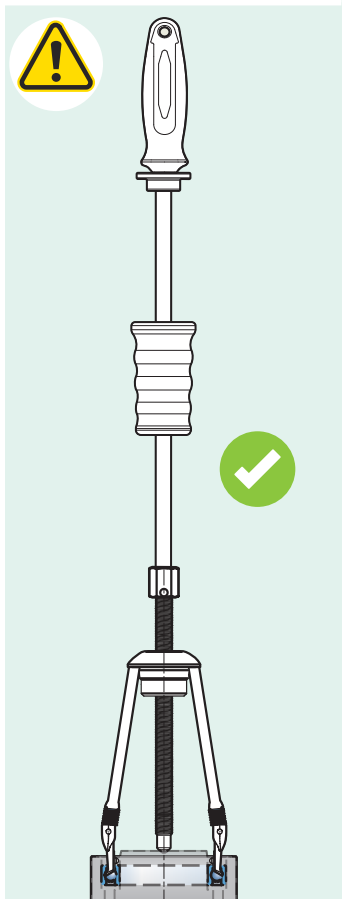
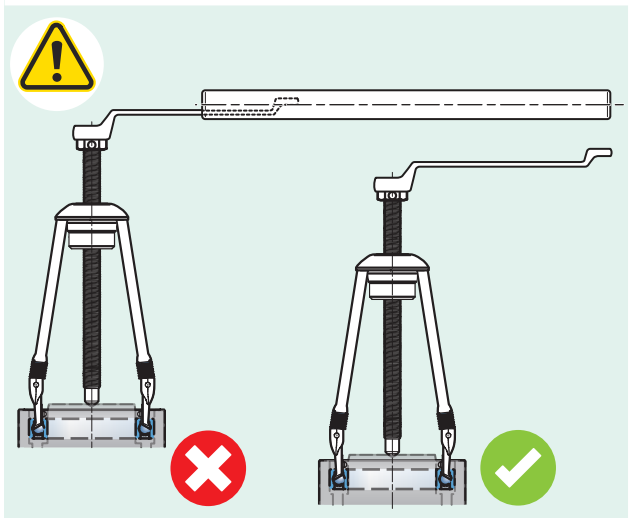
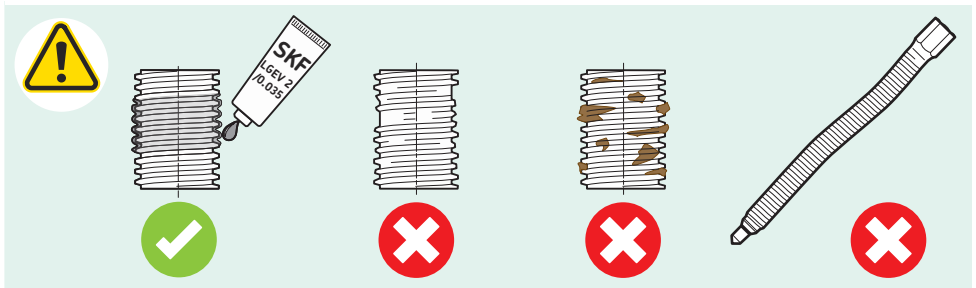
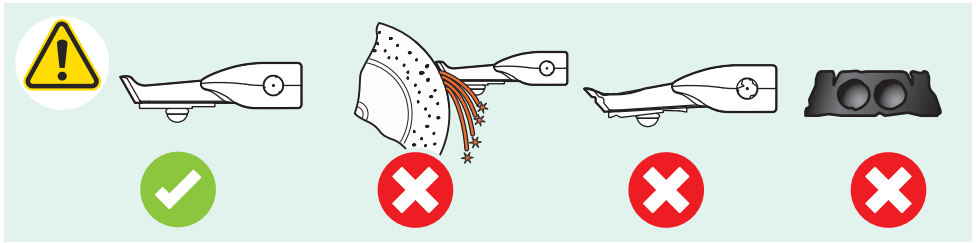

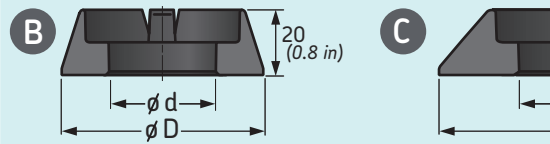
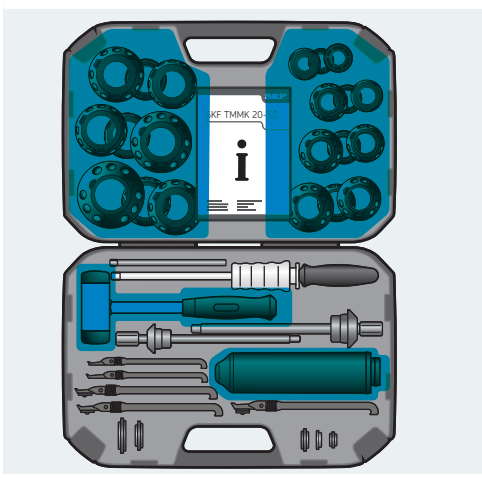
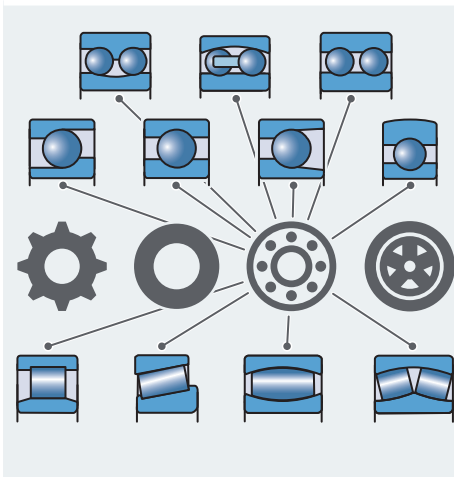
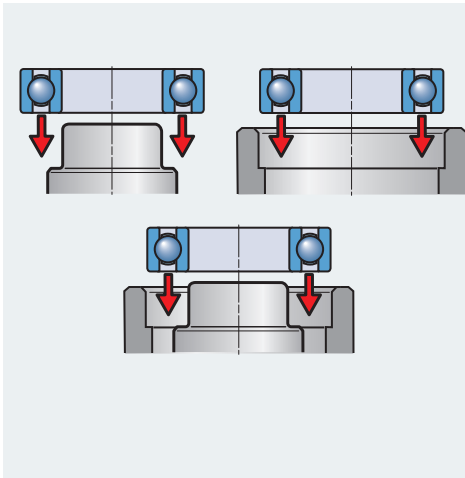

B	d		D		60.. 62
	mm	in	mm	in	
TMFT 36 B20-42	20	0.8	42	1.6	6004
TMFT 36 B20-47	20	0.8	47	1.8	6
TMFT 36 B20-52	20	0.8	52	2.0	
TMFT 36 B25-47	25	1.0	47	1.9	6005 62
TMFT 36 B25-52	25	1.0	52	2.0	6
TMFT 36 B25-62	25	1.0	62	2.4	
TMFT 36 B30-55	30	1.2	55	2.2	6006 62
TMFT 36 B30-62	30	1.2	62	2.4	6
TMFT 36 B30-72	30	1.2	72	2.8	
TMFT 36 B35-62	35	1.4	62	2.4	6007
TMFT 36 B35-72	35	1.4	72	2.8	6
TMFT 36 B35-80	35	1.4	80	3.1	

C	d		D		60.. 62
	mm	in	mm	in	
TMFT 36 C40-68	40	1.6	68	2.7	6008
TMFT 36 C40-80	40	1.6	80	3.1	6
TMFT 36 C40-90	40	1.6	90	3.5	
TMFT 36 C45-75	45	1.8	75	2.9	6009
TMFT 36 C45-85	45	1.8	85	3.3	6
TMFT 36 C45-100	45	1.8	100	3.9	
TMFT 36 C50-80	50	2.0	80	3.1	6010
TMFT 36 C50-90	50	2.0	90	3.5	6
TMFT 36 C50-110	50	2.0	110	4.3	

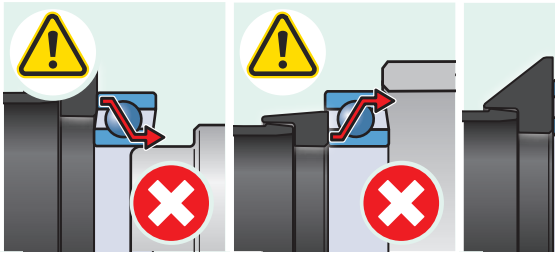

2.. 63.. 64.. 160..	
16004	
204	
6304	
2/22	16005
205 63/22	6305 6403
2/28	16006
206 63/28	6306 6404
16007	
207	6307 6405
2.. 63.. 64.. 160..	
16008	
208	6308 6406
16009	
209	6309 6407
16010	
210	6310 6408



1 ? ? ?

	d	D	B	mm in	mm in	mm in	60..	62..	64..	160..
TMT F 36 A10	10	0.4	26	1.0	6000					16100
TMT F 36 A20	10	0.4	30	1.2	6200					16100
TMT F 36 A10	10	0.4	35	1.4						16101
TMT F 36 A12	12	0.5	28	1.1	6001					16101
TMT F 36 A12	12	0.5	32	1.3	6203					16101
TMT F 36 A12	12	0.5	37	1.5						16101
TMT F 36 A15	15	0.6	32	1.3	6002					16101
TMT F 36 A15	15	0.6	35	1.4	6202					16101
TMT F 36 A15	15	0.6	42	1.7						16101
TMT F 36 A17	17	0.7	35	1.4	6003					16101
TMT F 36 A17	17	0.7	40	1.6	6201					16101
TMT F 36 A17	17	0.7	47	1.9						16101

? ? ?

2

3

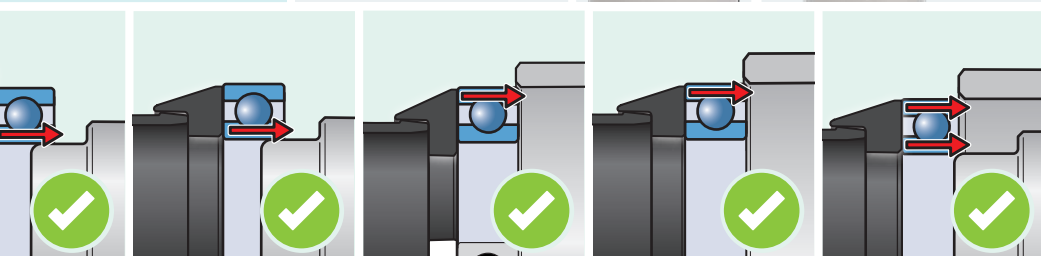

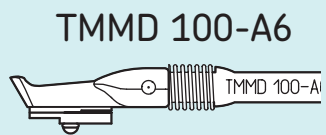
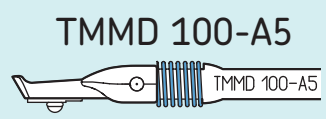
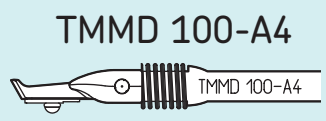
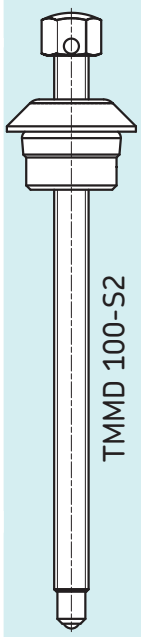
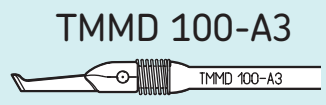
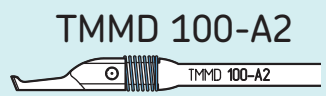
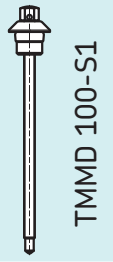
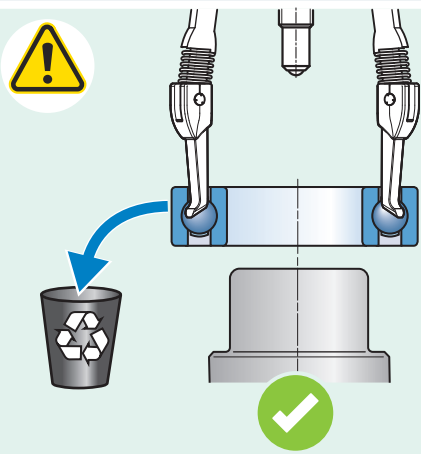
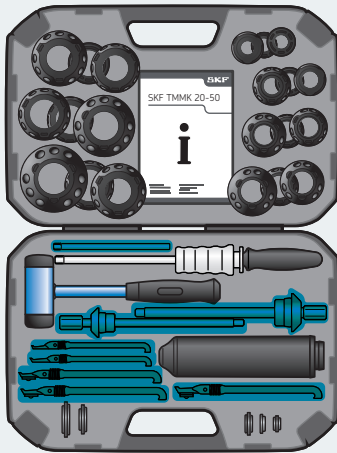
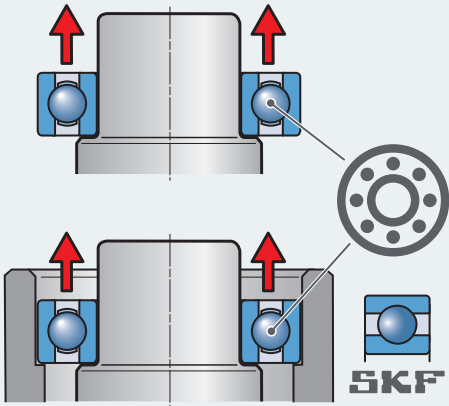



60..	62..	63..	64..	160..
------	------	------	------	-------

6004	6201			
6005	6202			
6006	6203			
6007	6204	6300		16011
6008	6205	6301		
6009	62/22	6302		
6010				



6206	6303
62/28	6304

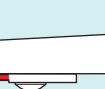

6011	63/22
6012	
6013	



6207	6305
6208	63/28

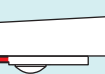

6014	6209	6306	6403
6015			

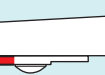

6016	6210	6307
6017	6211	

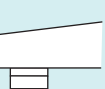

6018	6308	6404
6019		6405
6020		

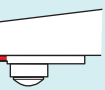

6212	6406
6213	

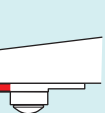

6214	6309	6407
6215	6310	
6216		
6217		



6218	6311	6408
	6312	6409



6313	6410
------	------

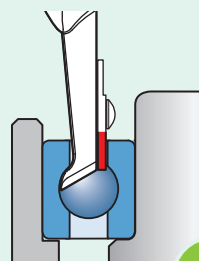
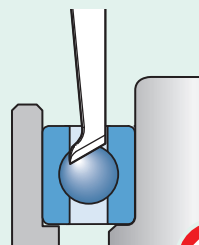
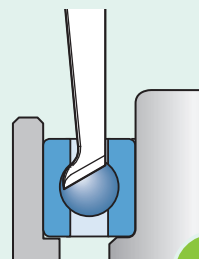
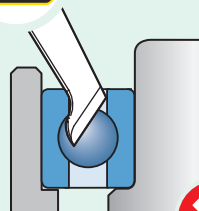

1 ? ? ?

	60.	62.	63.	64.	160.	161.
TMMD 100-A1	6000	6200	6300	6400	16000	16100
	6001			6401	16001	16101
	6002			6402	16002	16102
	6003			6403	16003	16103
TMMD 100-A2	6004	6201	6301	6404		
	6005	6202	6302	6405		
	6006	6203	6303	6406		
TMMD 100-A3	6007	6204	6300	6407	16011	
	6008	6205	6301	6408		
	6009	6222	6302	6409		
	6010			6410		
TMMD 100-A4	6206	6303				
	6208	6304				
	6212					
TMMD 100-A5	6207	6305				
	6208	6306	6308	6408		
	6209	6307				
	6210	6307				
	6211					
	6219	6308	6404			
	6220					
TMMD 100-A6	6212					
	6213					
	6214	6311				
	6215	6311				
	6216					
	6217					
	6218	6311				
	6219	6311				
	6220	6311				

6-7

2 A4 / A5 / A6

x3

6-7

3 I

5 II

~120°

6 II

7 III





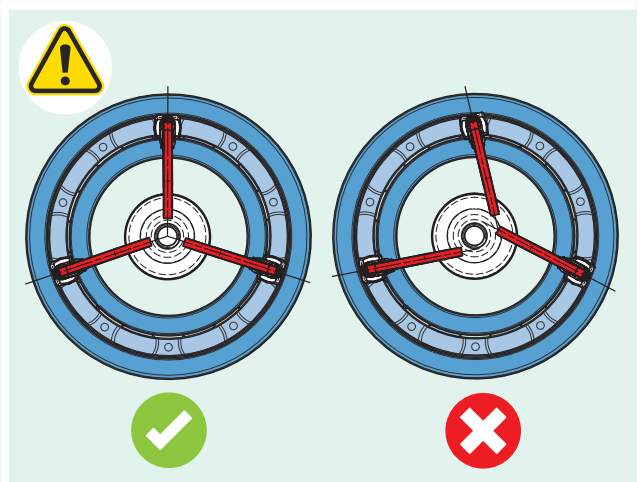
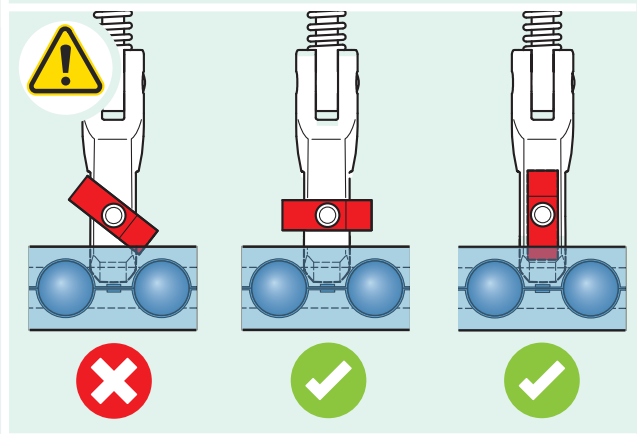
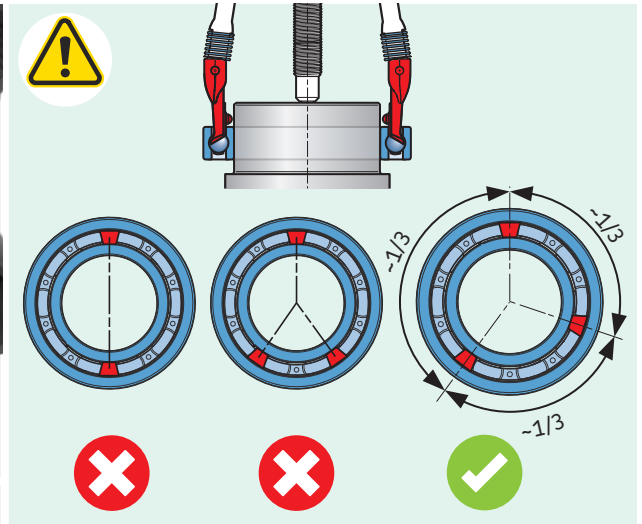

9

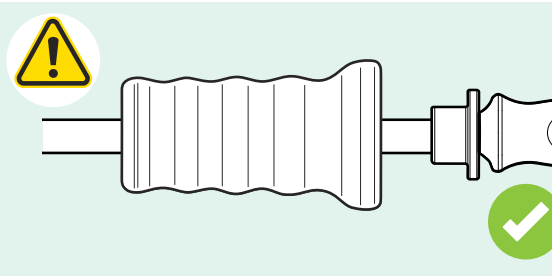
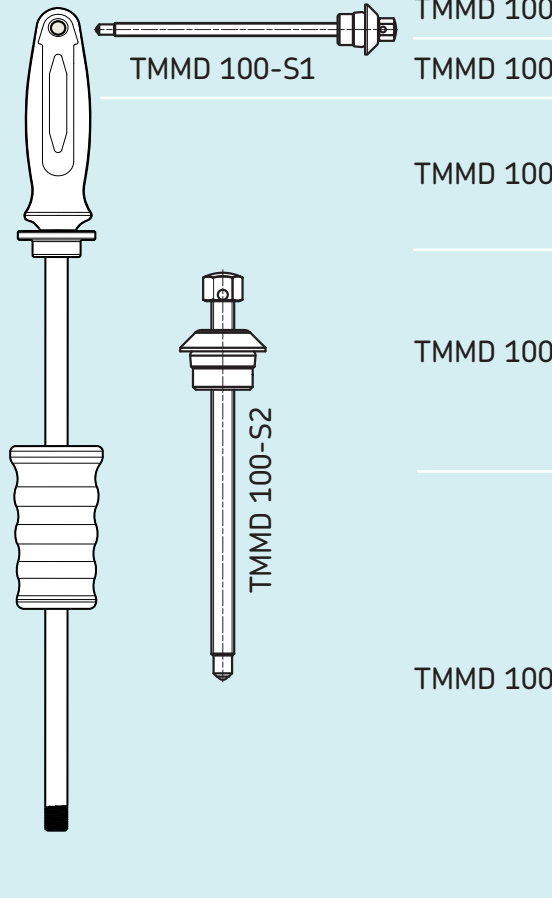
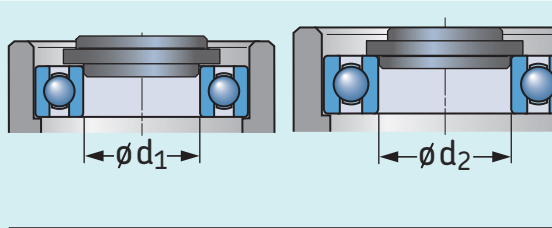
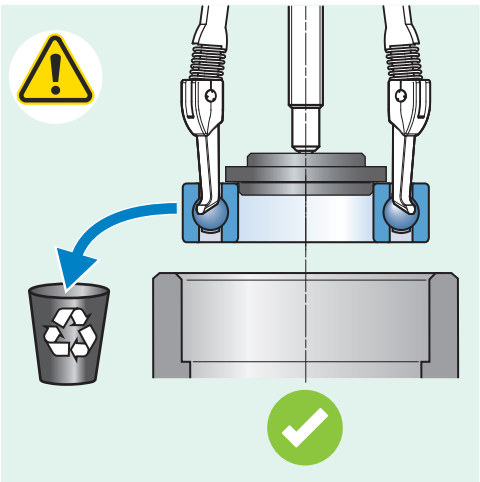
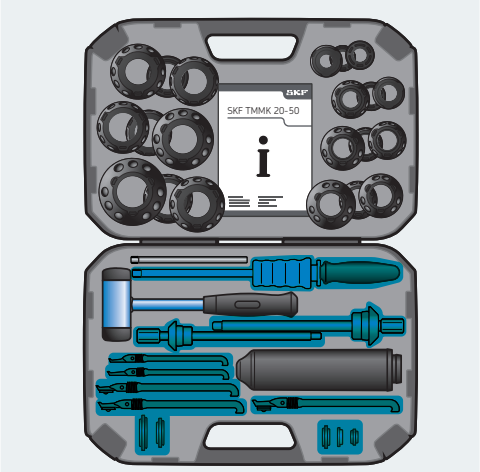
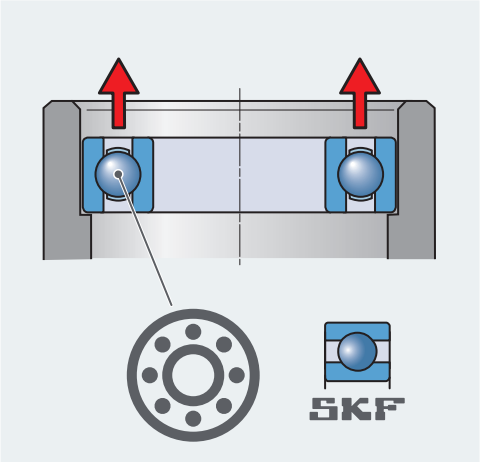
10

11



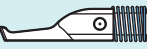
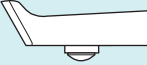

											
		d ₁	d ₂	d ₁	d ₁	d ₂	d ₁	d ₂	d ₁	d ₂	
	mm	20	22	25	28	30	35	40	45	50	
	in	0.8	0.9	1.0	1.1	1.2	1.4	1.6	1.8	2.0	
-A2		6004		6005		6006					
-A3		6204	62/22	6205				6007	6008	6009 6010	
-A4		6304				62/28	6206				
		63/22									
-A5				6305	63/28		6207 6208				
						6306		6209			
								6307	6210		
		6404	6405				6308				
-A6						6406					
								6407	6309 6310		
								6408	6409		
										6410	

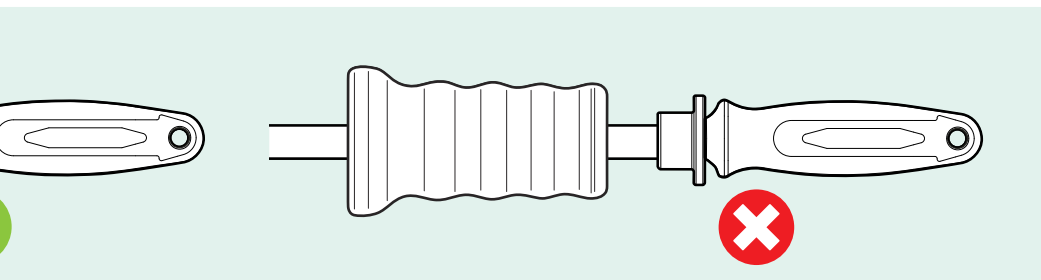

1

? ? ?

	d1	d2	d1	d2	d1	d2	d1	d2
mm	20	22	25	30	35	40	45	50
in	0.8	0.9	1.0	1.2	1.4	1.6	1.8	2.0
TMMD 100-A2	6004	6005	6006					
TMMD 100-S1				6007	6008	6009	6010	
TMMD 100-A3	6204	6222	6205					
TMMD 100-A4	6304		6278	6306				
		63/22						
TMMD 100-A5	6305	63/28		6207	6208			
			6306					
TMMD 100-S2				6307	6210			
TMMD 100-A6	6404	6405						

2 A4/A5/A6

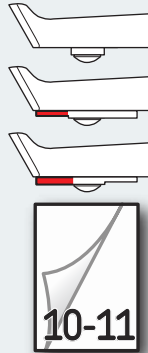

6

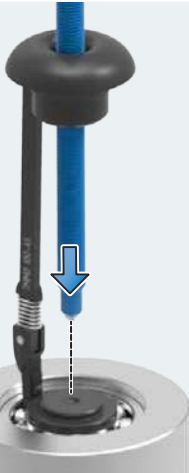

7



8

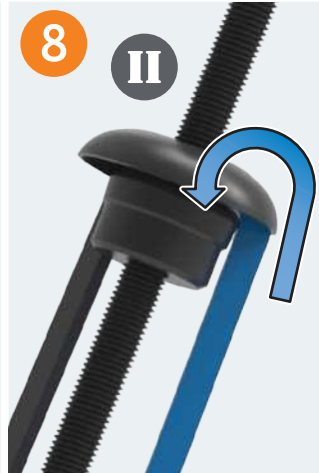

9



10



11



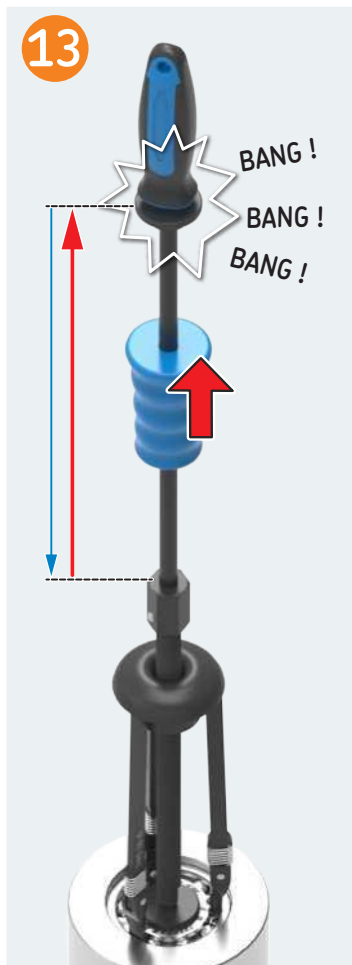
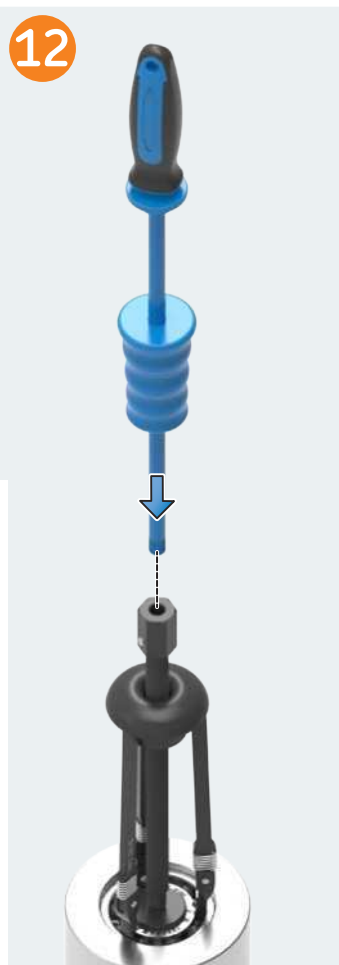
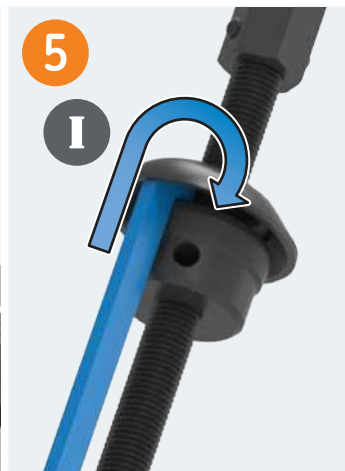

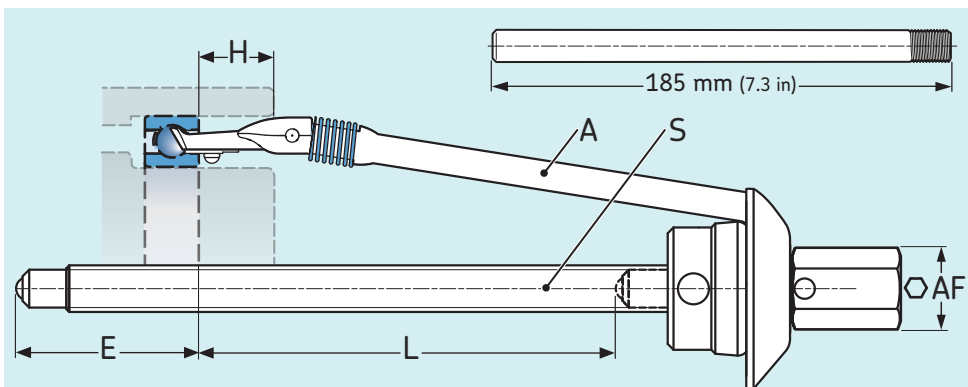

S	A	L	H	E	AF				
						mm	in	mm	in
TMMD 100-S1	TMMD 100-A2	135	5.3	16	0.6	79	3.1	19	3/4"
	TMMD 100-A3	137	5.4	23	0.9	77	3.0		
TMMD 100-S2	TMMD 100-A4	162	6.4	26	1.0	52	2.0	24	15/16"
	TMMD 100-A5	167	6.6	52	2.0	49	1.9		
	TMMD 100-A6	170	6.7	100	3.9	49	1.9		

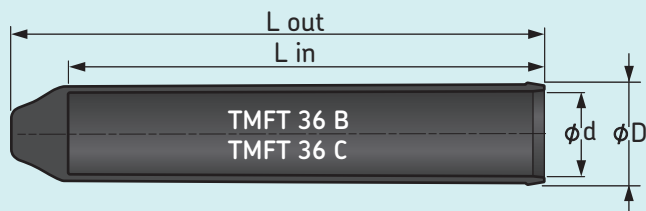

	d		D		L _{in}		L _{out}	
	mm	in	mm	in	mm	in	mm	in
TMFT 36 B	37	1.4	45	1.7	210	8.3	235	9.3
TMFT 36 C	57	2.2	66	2.6	215	8.4	245	9.6

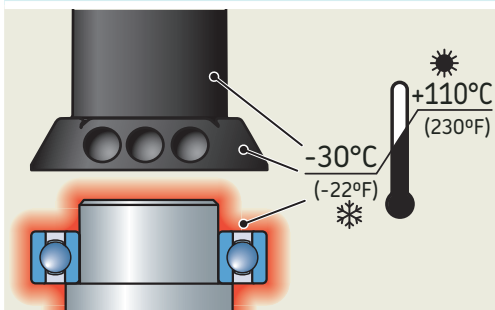
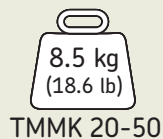

TDTC 1/C

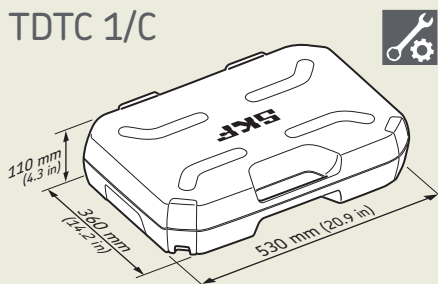

TMMX 210

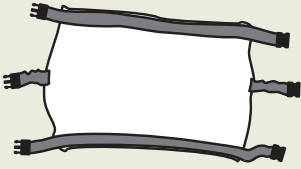

LGEV 2/0.035

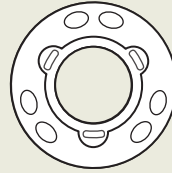

TMFT 36 B20-42 TMFT 36 B25-47
 TMFT 36 B20-47 TMFT 36 B25-52
 TMFT 36 B20-52 TMFT 36 B25-62
 TMFT 36 B30-55 TMFT 36 B35-62
 TMFT 36 B30-62 TMFT 36 B35-72
 TMFT 36 B30-72 TMFT 36 B35-80

TMFT 36-H

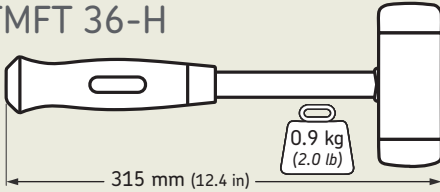

TMMD 100-A2

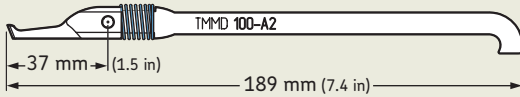

TMMD 100-A3

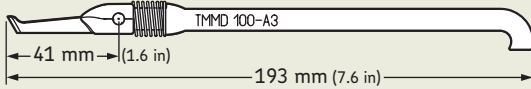

TMMD 100-A4

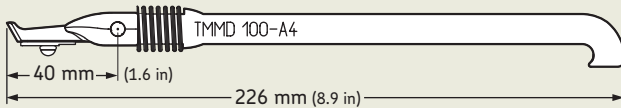

TMMD 100-A5

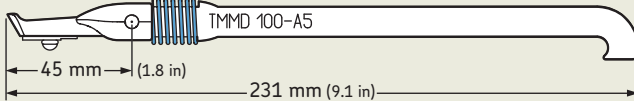

TMMD 100-A6

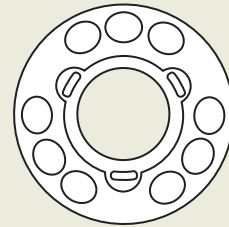
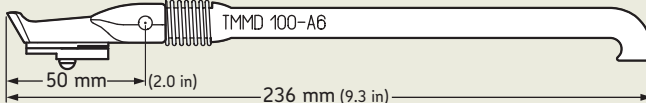

TMFT 36 C40-68 TMFT 36 C50-80
 TMFT 36 C40-80 TMFT 36 C50-90
 TMFT 36 C40-90 TMFT 36 C50-110
 TMFT 36 C45-75
 TMFT 36 C45-85
 TMFT 36 C45-100

TMIP S1

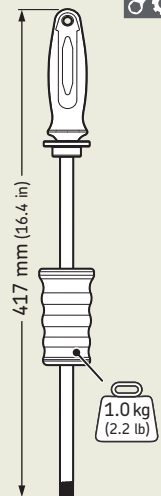

The contents of this publication are the copyright of the publisher and may not be reproduced (even extracts) unless prior written permission is granted. Every care has been taken to ensure the accuracy of the information contained in this publication but no liability can be accepted for any loss or damage whether direct, indirect or consequential arising out of the use of the information contained herein.

Nachdruck, auch auszugsweise, nur mit unserer vorherigen schriftlichen Genehmigung gestattet. Die Angaben in dieser Druckschrift wurden mit größter Sorgfalt auf ihre Richtigkeit hin überprüft. Trotzdem kann keine Haftung für Verluste oder Schäden irgendwelcher Art übernommen werden, die sich mittelbar oder unmittelbar aus der Verwendung der hier enthaltenen Informationen ergeben.

El contenido de esta publicación es propiedad de los editores y no puede reproducirse (incluso parcialmente) sin autorización previa por escrito. Se ha tenido el máximo cuidado para garantizar la exactitud de la información contenida en esta publicación, pero no se acepta ninguna responsabilidad por pérdidas o daños, ya sean directos, indirectos o consecuentes, que se produzcan como resultado del uso de dicha información.

Le contenu de cette publication est soumis au copyright de l'éditeur et sa reproduction, même partielle, est interdite sans autorisation écrite préalable. Le plus grand soin a été apporté à l'exactitude des informations données dans cette publication mais SKF décline toute responsabilité pour les pertes ou dommages directs ou indirects découlant de l'utilisation du contenu du présent document.

La riproduzione, anche parziale, del contenuto di questa pubblicazione è consentita soltanto previa autorizzazione scritta della SKF. Nella stesura è stata dedicata la massima attenzione al fine di assicurare l'accuratezza dei dati, tuttavia non si possono accettare responsabilità per eventuali errori od omissioni, nonché per danni o perdite diretti o indiretti derivanti dall'uso delle informazioni qui contenute.

O conteúdo desta publicação é de direito autoral do editor e não pode ser reproduzido (nem mesmo parcialmente), a não ser com permissão prévia por escrito. Todo cuidado foi tomado para assegurar a precisão das informações contidas nesta publicação, mas nenhuma responsabilidade pode ser aceita por qualquer perda ou dano, seja direto, indireto ou consequente como resultado do uso das informações aqui contidas.

Содержание этой публикации является собственностью издателя и не может быть воспроизведено (даже частично) без предварительного письменного разрешения. Несмотря на то, что были приняты все меры по обеспечению точности информации, содержащейся в настоящем издании, издатель не несёт ответственности за любой ущерб, прямой или косвенный, вытекающий из использования вышеуказанной информации.

本出版物内容的著作权归出版者所有且未经事先书面许可不得被复制(甚至引用)。我们已采取了一切注意措施以确定本出版物包含的信息准确无误,但我们不对因使用此等信息而产生的任何损失或损害承担任何责任,不论此等责任是直接、间接或附随性的。



skf.compro.skf.comf.com/mount

© is a registered trademark of the SKf Group.

© SKf Group 2022

MP5444 · 2022/07